

# ARCA

*boilers*

ARCA

# GRANOLA AUTOMATIC

Installation  
Use  
Maintenance





ARCA s.r.l. declines all liability for any imprecisions due to transcription or printing errors. It likewise reserves the right to make any changes to its products that it considers necessary or useful, without these affecting the essential features of such products. This documents is also available as a PDF file. To request a copy contact the ARCA s.r.l. technical department.

# CONTENTS

<b>1.</b>	<b>GENERAL WARNINGS</b>	<b>6</b>
<b>2.</b>	<b>TECHNICAL SPECIFICATIONS AND DIMENSIONS</b>	<b>7</b>
2.1.	TECHNICAL SPECIFICATIONS AND DIMENSIONS OF MODELS GRA14RO, GRA20RO, GRA30RO	7
2.2.	TECHNICAL SPECIFICATIONS AND DIMENSIONS OF MODELS GRA40RO, GRA50RO	8
2.3.	TECHNICAL SPECIFICATIONS AND DIMENSIONS OF MODELS GRA80RO	9
2.4.	TECHNICAL SPECIFICATIONS AND DIMENSIONS OF MODELS GRA115RO, GRA150RO	9
<b>3.</b>	<b>MAIN PARTS OF THE BOILER</b>	<b>10</b>
3.1.	FUEL FEED SCREW FOR MODELS GRANOLA 14, 20, 30, 40, 50	10
3.2.	SCREW (CODE COC0502) FOR MODELS GRA80RO, GRA115RO & GRA150RO	11
3.3.	TANK (CODE CON0600) FOR MODELS GRA80RO, GRA115RO & GRA150RO	11
3.4.	PELLET BURNER	12
3.5.	BOILER HEAT EXCHANGER AND FURNACE	12
3.6.	SMOKEBOX AND FAN	13
3.7.	WATER TEMPERATURE PROBE SOCKETS	13
3.8.	RECIRCULATING PUMP (ANTI-CONDENSATION)	13
3.9.	SUPPLY WATER	13
3.10.	INSULATION	13
<b>4.</b>	<b>INSTALLATION</b>	<b>14</b>
4.1.	POSITIONING IN THE BOILER ROOM	14
4.2.	EXPANSION VESSELS	14
4.3.	CHIMNEY	14
<b>5.</b>	<b>SY400 ELECTRONIC PANEL (CODE PEL0100DUO)</b>	<b>15</b>
5.1.	DISPLAY	15
5.2.	ELECTRONIC BOARD	16
5.3.	PROBE CONNECTIONS	17
5.4.	FLUE GAS PROBE CONNECTION	17
5.5.	TERMINAL BLOCK WIRING CONNECTIONS	18
<b>6.</b>	<b>COMMISSIONING AND OPERATION</b>	<b>19</b>
6.1.	BOILER IN STANDBY	19
6.2.	BOILER IGNITION	19
6.3.	FLAME STABILISATION	19
6.4.	NORMAL OPERATION	20
6.5.	BOILER TEMPERATURE SETTING	20
6.6.	MODULATION	20
6.7.	MAINTENANCE	20
6.8.	TOTAL SHUTDOWN	21
<b>7.</b>	<b>USER MENU</b>	<b>21</b>
7.1.	WATER CIRCUIT CONFIGURATION MENU (ENABLE PROBES)	22
7.2.	DISPLAY MENU (DISPLAY PROBE READINGS)	23
7.3.	CLOCK MENU	25
7.4.	TIMER PROGRAMMING MENU	26
7.5.	MANUAL SCREW LOADING MENU	31
7.6.	TEST MENU	31
7.7.	SUMMER / WINTER OPERATION	34
<b>8.</b>	<b>WATER CIRCUIT DIAGRAMS</b>	<b>34</b>
8.1.	EXAMPLE DIAGRAMS FOR HEATING-ONLY SYSTEM WITH OPEN VESSEL	34
8.1.1.	EXAMPLE DIAGRAM FOR HEATING-ONLY WITH OPEN VESSEL	35
8.1.2.	EXAMPLE DIAGRAM FOR HEATING-ONLY WITH OPEN VESSEL WITH MIXING VALVE	35
8.1.3.	EXAMPLE DIAGRAM FOR HEATING-ONLY WITH PLATE HEAT EXCHANGER	36
8.2.	EXAMPLE DIAGRAMS FOR HEATING SYSTEM WITH DOMESTIC HOT WATER STORAGE CYLINDER	36
8.2.1.	EXAMPLE DIAGRAM FOR HEATING WITH DOMESTIC HOT WATER STORAGE CYLINDER	37
8.2.2.	EXAMPLE DIAGRAM FOR HEATING WITH TWO-COIL DHW STORAGE CYLINDER AND SOLAR PANELS	38

8.2.3.	EXAMPLE DIAGRAM FOR HEATING WITH CLOSED VESSEL, PLATE HEAT EXCHANGER, TWO-COIL DHW STORAGE CYLINDER AND SOLAR PANELS .....	38
8.3.	EXAMPLE DIAGRAMS FOR HEATING SYSTEM WITH BUFFER TANK OR COMBI BUFFER TANK .....	39
8.3.1.	EXAMPLE DIAGRAM FOR HEATING WITH COMBI BUFFER TANK AND SOLAR PANELS.....	40
8.3.2.	EXAMPLE DIAGRAM FOR HEATING WITH CLOSED VESSEL, PLATE HEAT EXCHANGER, COMBI BUFFER TANK AND SOLAR PANELS.....	40
8.4.	EXAMPLE DIAGRAMS FOR HEATING SYSTEM WITH DOMESTIC HOT WATER STORAGE CYLINDER AND BUFFER TANK .....	41
8.4.1.	EXAMPLE DIAGRAM FOR WITH BUFFER TANK, TWO-COIL DHW STORAGE CYLINDER AND SOLAR PANELS .....	42
<b>9.</b>	<b>CENTRAL HEATING SYSTEM CONNECTION TO “N” ZONES .....</b>	<b>43</b>
<b>10.</b>	<b>MAINTENANCE AND CLEANING .....</b>	<b>44</b>
10.1.	WEEKLY CLEANING .....	44
10.2.	MONTHLY MAINTENANCE.....	44
10.3.	ANNUAL MAINTENANCE (PERFORMED BY THE SERVICE CENTRE).....	45
<b>11.</b>	<b>TROUBLESHOOTING .....</b>	<b>45</b>
11.1.	CONTROL PANEL TROUBLESHOOTING .....	45
11.2.	BOILER TROUBLESHOOTING .....	46

## 1. GENERAL WARNINGS

This instruction booklet is an integral and essential part of the product and must be provided to the user. Carefully read the warnings contained in this booklet, as these provide important safety instructions for the installation, use and maintenance of the product. This booklet should be carefully kept for future reference.

The appliance must be installed by professionally qualified personnel or by our service centre in compliance with local legislation in force and the instructions provided by the manufacturer. The manufacturer is not liable for any damage caused to people, animals or things due to incorrect installation.

Make sure the product is complete. In case of doubt do not use the product and contact the supplier. The parts of the packaging must not be disposed of into the environment or left within the reach of children.

Before performing any settings, maintenance or cleaning operations, disconnect the appliance from the mains power supply using the system switch and/or the corresponding on-off devices.

In the event of faults and/or malfunctioning of the appliance, it should be deactivated. Do not attempt to repair the appliance. Contact professionally qualified personnel only. Any repairs must only be carried out by a manufacturer's authorised service centre, exclusively using original spare parts.

**The manufacture declines all liability, whether contractual or otherwise, for damage due to improper installation or use and in any case failure to observe the instructions shown in this manual.**

**Failure to heed the above warning may affect the effectiveness of the system or its individual components, causing potential harm to the user. The manufacturer accepts no liability whatsoever in such circumstances.**

### **WARNING !**

**The boiler must be commissioned and tested by an authorised service centre.**

## 2. TECHNICAL SPECIFICATIONS AND DIMENSIONS

### 2.1. Technical specifications and dimensions of models GRA14RO, GRA20RO and GRA30RO

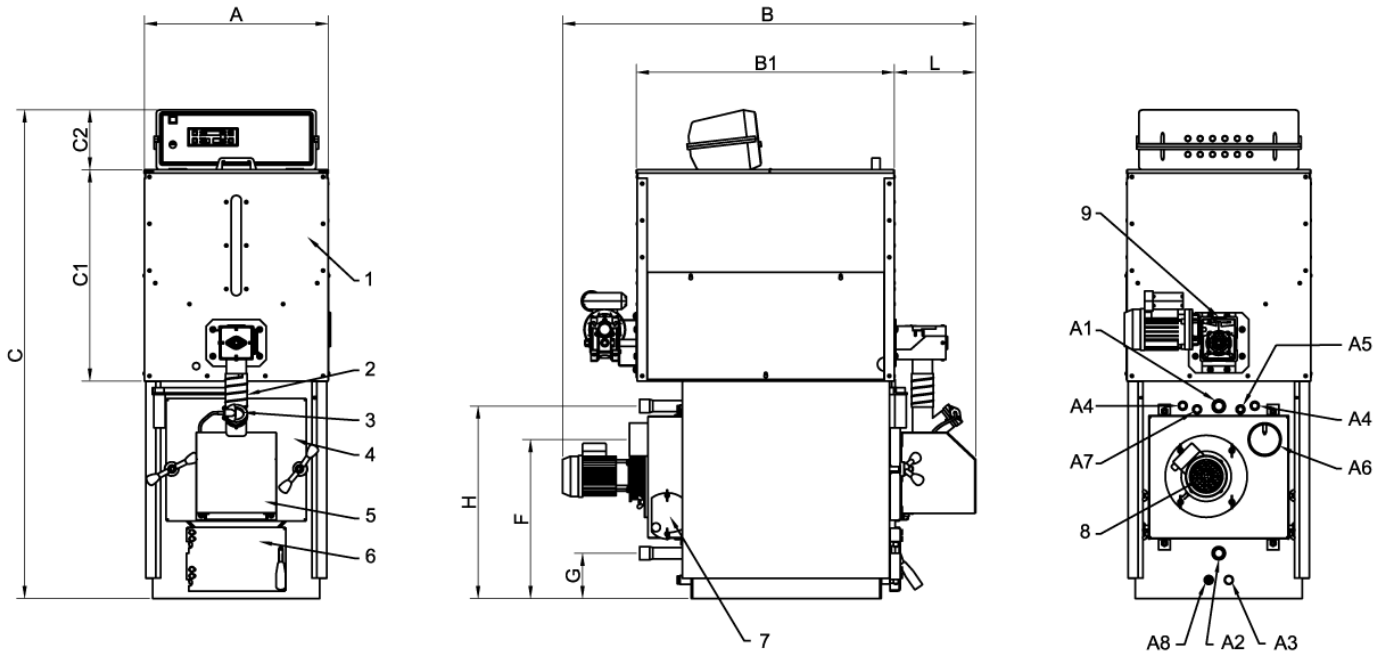

#### Key:

- |   |   |    |  |
|---|---|----|--|
| 1 | Fuel container (granular fuel storage)        | A1 | Central heating flow outlet            |
| 2 | Fuel inlet                                    | A2 | Central heating return inlet           |
| 3 | Flame inspection opening                      | A3 | Boiler drain                           |
| 4 | Top door (furnace)                            | A4 | Safety heat exchanger attachments      |
| 5 | Burner cover plate                            | A5 | Boiler probe socket attachment (S4)    |
| 6 | Bottom door (ash dump)                        | A6 | Chimney attachment                     |
| 7 | Cleanout door                                 | A7 | Thermal relief valve socket attachment |
| 8 | Fan motor (flue gas exhaust)                  | A8 | Boiler probe socket attachment (S5)    |
| 9 | Fuel container screw gear motor (fuel supply) |    |  |

Model	Minimum heat output	Maximum heat output	Minimum heat input	Maximum heat input	Weight kg	Fuel container capacity kg	Boiler capacity litres	Water side pressure drop mbar.	Flue gas side pressure drop mbar.	Operating pressure bar.	Max test pressure bar.
	kcal/h kW	kcal/h kW	kcal/h kW	kcal/h kW							
GRA14RO	5.040 6	12.068 14	6.020 7	13.330 15,5	200	110	47	10	0.03	3	4.5
GRA20RO	8.600 10	17.200 20	9.460 11	18.920 22	200	110	47	10	0.03	3	4.5
GRA30RO	17.200 20	25.800 30	18.920 22	28.380 33	280	196	68	10	0.03	3	4.5

Model	A	B	B1	C	C1	C2	L	H	F	G	A1	A2	A3	A4	A5	A6	A7	A8
	mm	mm	mm	mm	mm	mm	mm	mm	mm	mm	∅	∅	∅	∅	∅	∅	∅	∅
GRA14RO	550	1237	770	1460	632	180	243	575	475	135	1"	½"	½"	½"	½"	99	½"	½"
GRA20RO	550	1237	770	1460	632	180	243	575	475	135	1"	½"	½"	½"	½"	99	½"	½"
GRA30RO	620	1310	900	1600	830	180	260	715	560	170	1" ¼	½"	½"	½"	½"	138	½"	½"

## 2.2. Technical specifications and dimensions of models GRA40RO and GRA50RO

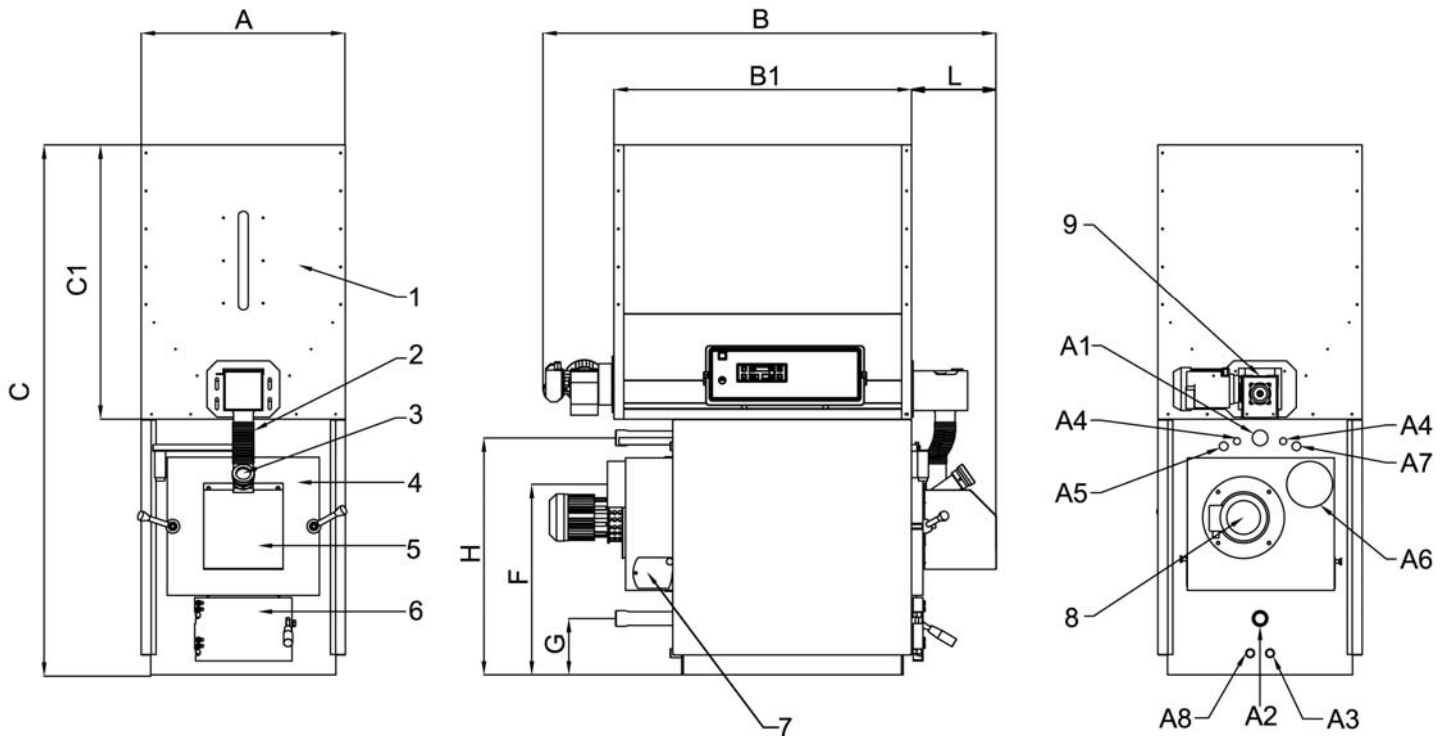

### Key:

- |   |   |    |  |
|---|---|----|--|
| 1 | Fuel container (granular fuel storage)        | A1 | Central heating flow outlet            |
| 2 | Fuel inlet                                    | A2 | Central heating return inlet           |
| 3 | Flame inspection opening                      | A3 | Boiler drain                           |
| 4 | Top door (furnace)                            | A4 | Safety heat exchanger attachments      |
| 5 | Burner cover plate                            | A5 | Boiler probe socket attachment (S4)    |
| 6 | Bottom door (ash dump)                        | A6 | Chimney attachment                     |
| 7 | Cleanout door                                 | A7 | Thermal relief valve socket attachment |
| 8 | Fan motor (flue gas exhaust)                  | A8 | Boiler probe socket attachment (S5)    |
| 9 | Fuel container screw gear motor (fuel supply) |    |  |

Model	Minimum heat output	Maximum heat output	Minimum heat input	Maximum heat input	Weight	Fuel container capacity	Boiler capacity	Water side pressure drop	Flue gas side pressure drop	Operating pressure	Max test pressure
	kcal/h kW	kcal/h kW	kcal/h kW	kcal/h kW							
GRA40RO	25800 30	34400 40	28380 33	37840 44	370	280	117	10	0.06	3	4.5
GRA50RO	34400 40	43000 50	37840 44	47300 55	370	280	117	10	0.06	3	4.5

Model	A	B	B1	C	C1	L	H	F	G	A1	A2	A3	A4	A5	A6	A7	A8
	mm	mm	mm	mm	mm	mm	mm	mm	mm	ø	ø	ø	ø	ø	ø	ø	ø
GRA40RO	690	1510	1100	1780	830	260	880	763	192	1" ¼	½"	½"	½"	½"	150	½"	½"
GRA50RO	690	1510	1100	1780	830	260	880	763	192	1" ¼	½"	½"	½"	½"	150	½"	½"



### 2.3. Technical specifications and dimensions of models GRA80RO

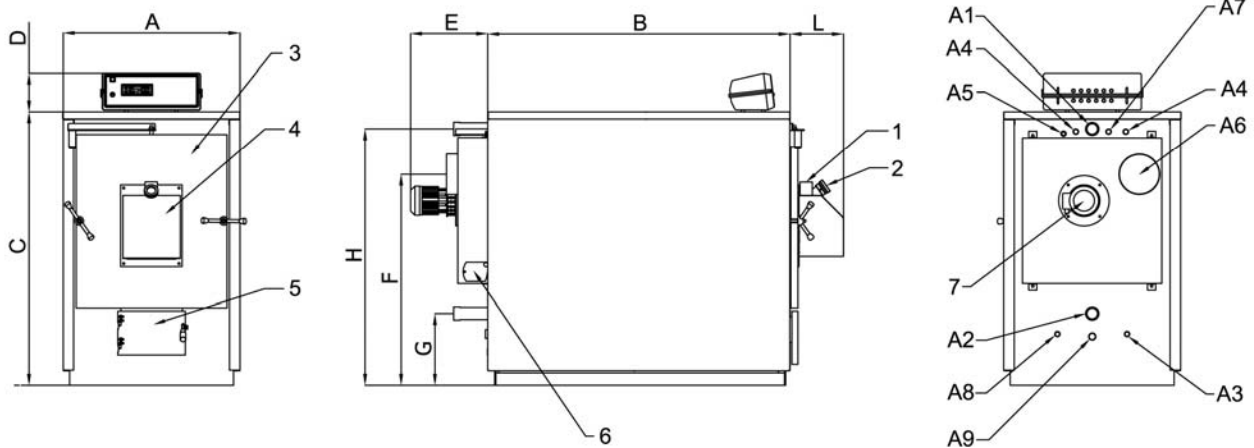

**Key:**

- |                                |   |
|--------------------------------|---|
| 1 Fuel inlet                   | A2 Central heating return inlet           |
| 2 Flame inspection opening     | A3 Boiler drain                           |
| 3 Top door (furnace)           | A4 Safety heat exchanger attachments      |
| 4 Burner cover plate           | A5 Boiler probe socket attachment (S4)    |
| 5 Bottom door (ash dump)       | A6 Chimney attachment                     |
| 6 Cleanout door                | A7 Thermal relief valve socket attachment |
| 7 Fan motor (flue gas exhaust) | A8 Boiler probe socket attachment (S5)    |
| A1 Central heating flow outlet | A9 Available for cleaning accessories     |

Model	Minimum heat output kcal/h kW	Maximum heat output kcal/h kW	Minimum heat input kcal/h kW	Maximum heat input kcal/h kW	Weight kg	Boiler capacity litres	Water side pressure drop mbar.	Flue gas side pressure drop mbar.	Operating pressure bar.	Max test pressure bar.
GRA80RO	60200 70	68800 80	66220 77	75680 88	400	190	5	0.03	3	4.5

Model	A mm	B mm	C mm	D mm	H mm	F mm	G mm	E mm	L mm	A1 ø	A2 ø	A3 ø	A4 ø	A5 ø	A6 ø	A7 ø	A8 ø	A9 ø
GRA80RO	768	1120	1129	190	1035	870	380	376	260	1" ¼	½"	½"	½"	½"	178	½"	½"	28

### 2.4. Technical specifications and dimensions of models GRA115RO and GRA150RO

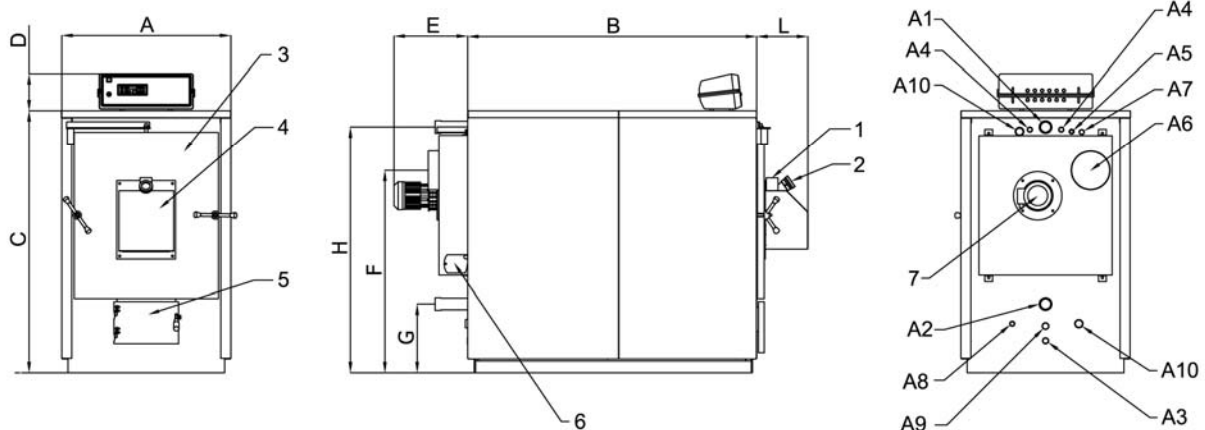

**Key:**

- |                                 |   |
|---------------------------------|---|
| 1 Fuel inlet                    | A3 Boiler drain                                       |
| 2 Flame inspection opening      | A4 Safety heat exchanger attachments                  |
| 3 Top door (furnace)            | A5 Boiler probe socket attachment (S4)                |
| 4 Burner cover plate            | A6 Chimney attachment                                 |
| 5 Bottom door (ash dump)        | A7 Thermal relief valve socket attachment             |
| 6 Cleanout door                 | A8 Boiler probe socket attachment (S5)                |
| 7 Fan motor (flue gas exhaust)  | A9 Available for cleaning accessories                 |
| A1 Central heating flow outlet  | A10 Recirculating pump attachment (anti-condensation) |
| A2 Central heating return inlet |   |

Model	Minimum heat output	Maximum heat output	Minimum heat input	Maximum heat input	Weight kg	Boiler capacity litres	Water side pressure drop mbar.	Flue gas side pressure drop mbar.	Operating pressure bar.	Max test pressure bar.
	kcal/h kW	kcal/h kW	kcal/h kW	kcal/h kW						
GRA115RO	77400 90	94600 110	85140 99	98900 115	560	276	10	0.05	3	4.5
GRA150RO	103200 120	129000 150	113520 132	141900 165	670	362	12	0.05	3	4.5

Model	A	B	C	D	H	F	G	E	L	A1	A2	A3	A4	A5	A6	A7	A8	A9	A10
	mm	mm	mm	mm	mm	mm	mm	mm	mm	ø	ø	ø	ø	ø	ø	ø	ø	ø	ø
GRA115RO	862	1130	1352	190	1253	1030	350	376	260	2"	½"	¾"	½"	200	½"	½"	28	1"	
GRA150RO	862	1480	1352	190	1253	1030	350	376	260	2"	½"	¾"	½"	200	½"	½"	28	1"	

### 3. MAIN PARTS OF THE BOILER

#### 3.1. Fuel feed screw for models GRANOLA 14, 20, 30, 40, 50

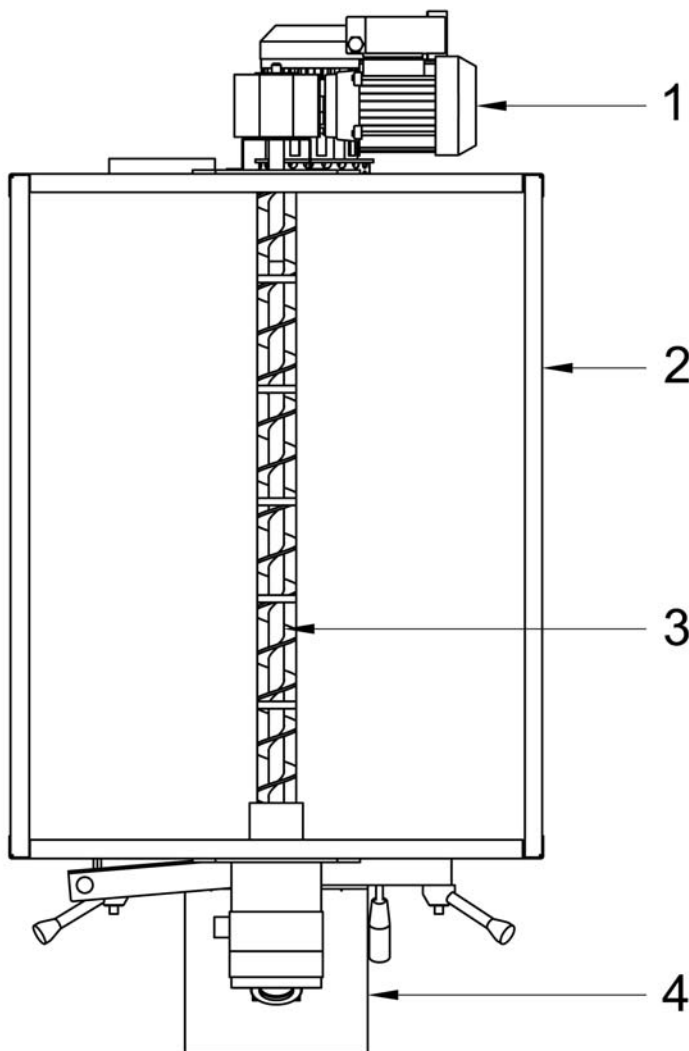

Key:

1. Screw gear motor
2. Pellet container
3. Fuel feed screw
4. Pellet burner

The fuel container located above the boiler body includes the feed screw; this is managed automatically by the electronic panel based on the parameter settings.

TOP VIEW (CONTAINER LOCATED ABOVE THE BOILER BODY)

### 3.2. Screw (CODE COC0502) for models GRA80RO, GRA115RO, GRA150RO

In versions 80, 115 and 150 the screw is supplied separately.  
Versions 30, 40, 50 can be supplied with the fuel container and screw separately on request.

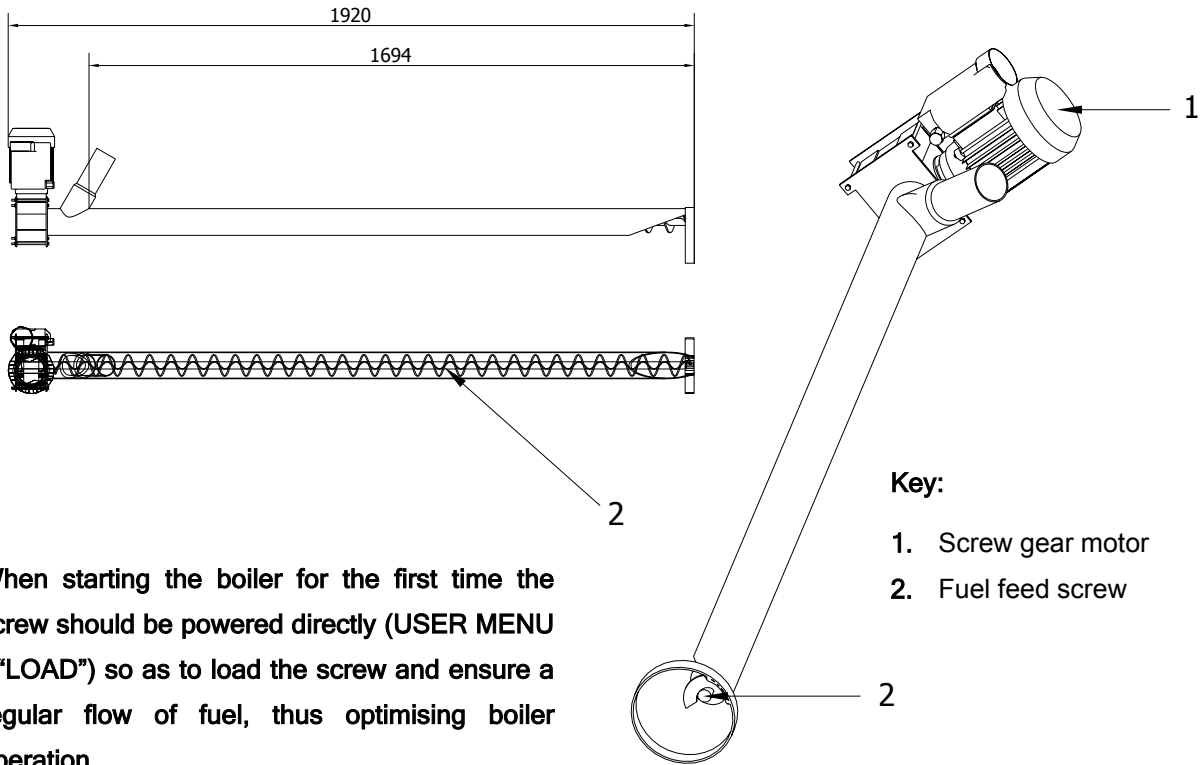

When starting the boiler for the first time the screw should be powered directly (USER MENU - "LOAD") so as to load the screw and ensure a regular flow of fuel, thus optimising boiler operation.

### 3.3. Tank (CODE CON0600) for models GRA80RO, GRA115RO, GRA150RO

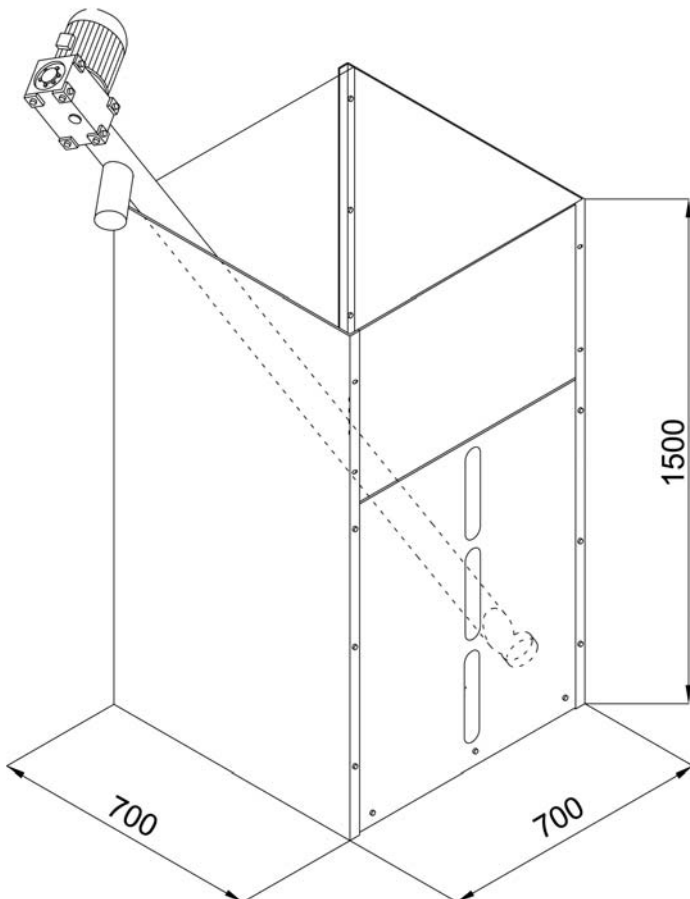

#### **WARNING**

for correct screw operation this should be kept at the maximum possible incline.

### 3.4. Pellet burner

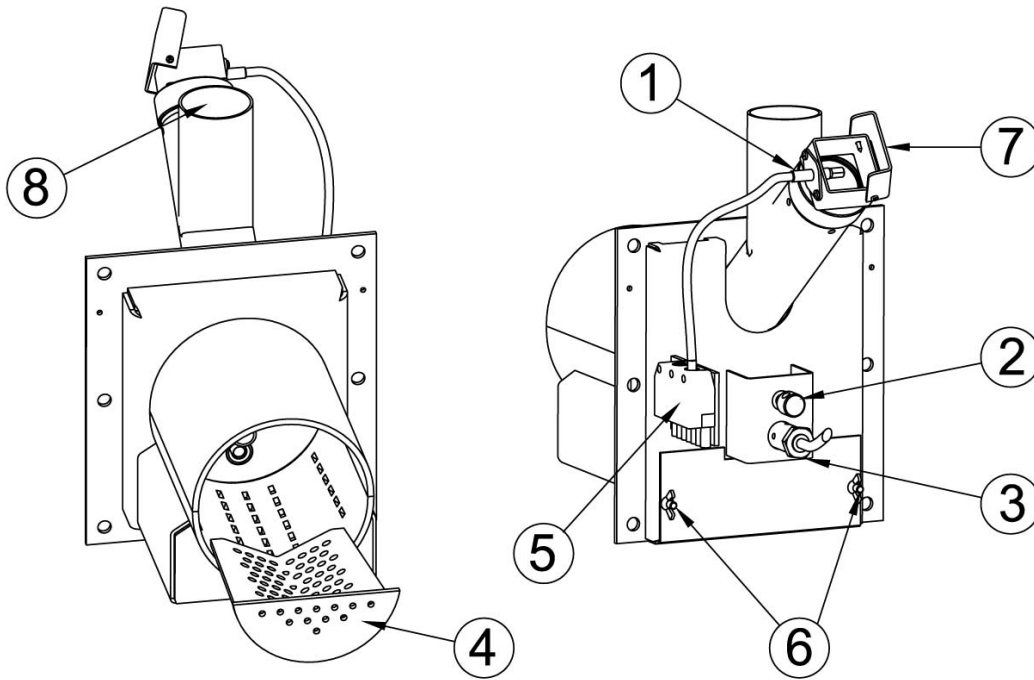

**WARNING:**  
The cover on inspection opening 7 must be kept closed during ignition and shut-down.

**Key:**

1	Photocell	5	Power outlet for boiler panel connection
2	Secondary air adjustment	6	Door for primary air adjustment
3	Ignition heater	7	Flame inspection opening cover
4	Stainless steel perforated grid plate	8	Pellet inlet

### 3.5. Boiler heat exchanger and furnace

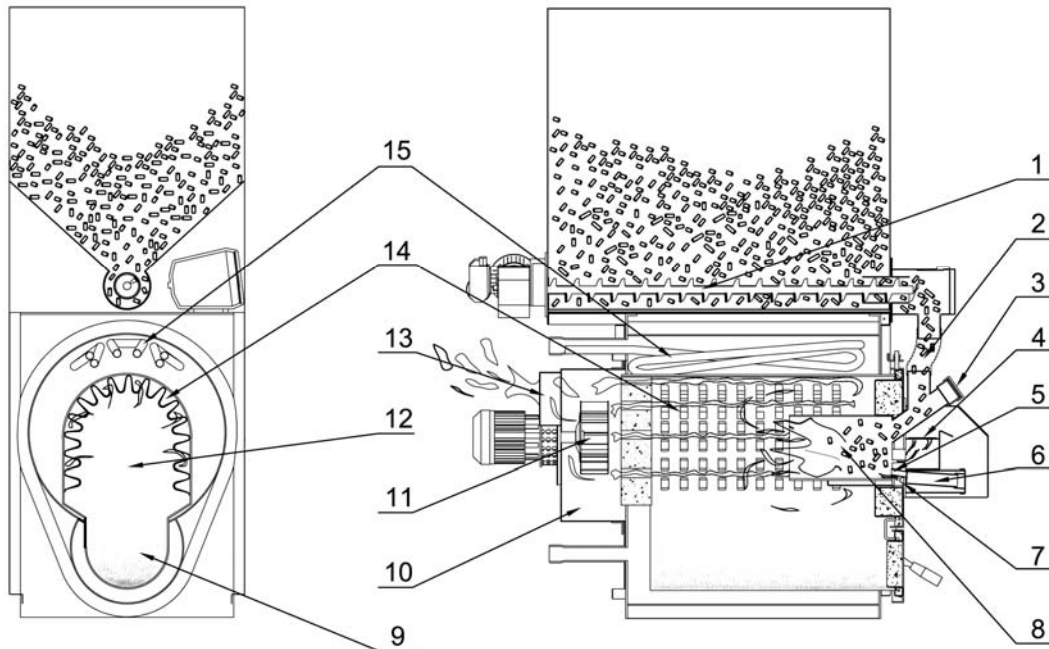

**Key:**

1	Screw	9	Ash dump
2	Fuel supply	10	Smokebox
3	Flame inspection opening	11	Fan
4	Secondary air	12	Furnace with dry heat exchanger
5	Ignition heater	13	Flue gas outlet
6	Electric heater housing	14	Dry heat exchanger
7	Primary air	15	Safety heat exchanger
8	Burner draught tube		

### 3.6. Smokebox and fan

The combustion gas, after having given up energy to the water, accumulates inside the smokebox located at the rear of the boiler. The smokebox houses the two-speed fan, fitted horizontally and consisting of an electric motor and impeller. The fan allows easy maintenance, being secured in place using wing nuts.

### 3.7. Water temperature probe sockets

At the rear of the boiler are two identical sockets, A5 and A7, both with a 1/2" coupling, and have the following function:

- housing for the copper sheath that holds the probes connected to the electronic control panel;
- free housing for a second copper sheath or temperature measuring device (thermal relief valve).

### 3.8. Recirculating pump (anti-condensation)

To minimise the possibility of condensate forming in the wood-fired boiler, a recirculating pump needs to be installed. The pump is connected between the outlet (A1) and return (A2) fittings, with the direction of flow from top down. ARCA supplies a recirculating pump kit as an accessory, including pump, connection piping and fittings.

**For correct boiler operation the recirculating pump must be installed.**

**THE WARRANTY WILL BE VOID IF  
THE RECIRCULATING PUMP IS NOT INSTALLED**

### 3.9. Supply water

For correct operation and safety of the central heating system information must be available on the chemical-physical characteristics of the system and top-up water. The main problem caused by using very hard water is fouling of the heat exchange surfaces. It's well known that high concentrations of calcium and magnesium carbonates (lime scale) precipitate when heating, forming scale. These lime deposits have low thermal conductivity and consequently prevent heat exchange, creating localised overheating that weakens the metal structures, leading to breakage. It's therefore recommended to adopt water treatment in the following cases:

- very hard top-up water (over 20°F)
- high capacity (large) systems
- frequent topping up due to leaks
- frequent filling due to maintenance on the system.

**IMPORTANT:** if the boiler is used as a replacement in an existing system, this should be washed chemically beforehand using alkaline dispersants.

### 3.10. Insulation

The Granola automatic boiler is insulated by a 60 mm thick layer of mineral wool placed in contact with the boiler body, in turn protected by the outer casing, made from epoxy powder coated steel panels.

## 4. INSTALLATION

The Granola AUTOMATIC boiler is no different from a normal solid fuel boiler; therefore, there are no specific installation instructions beyond the safety requirements of the relevant standards in force. The room must be well ventilated; ventilation openings must have a minimum total surface area no less than  $0.5 \text{ m}^2$ . To simplify cleaning of the flue gas circuit, a free space no less than the length of the boiler should be left at the front, making sure that the door can open  $90^\circ$  without being obstructed.

The boiler can rest directly on the floor, as it comes with a self-supporting frame. Nonetheless, in very damp boiler rooms, a concrete base is recommended. Once installation is complete the boiler must be perfectly horizontal and stable so as to reduce any vibrations and noise.

### 4.1. Positioning in the boiler room

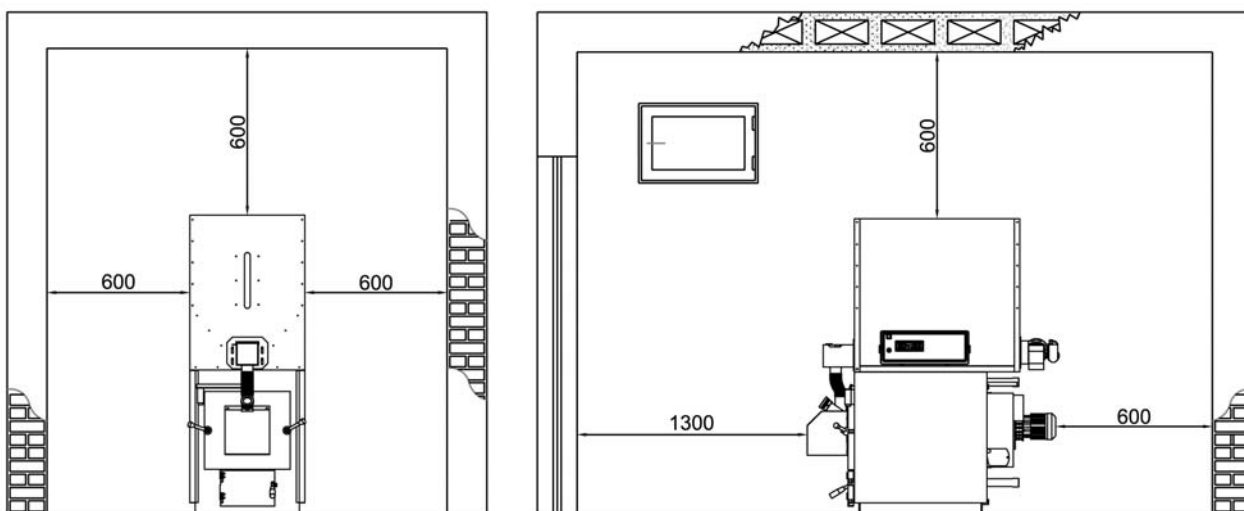

The boiler must be installed in the boiler room in compliance with the relevant legislation in force (for further details contact your local fire station)

The distances for positioning the boiler in the boiler room are illustrated below.

### 4.2. Expansion vessels

In accordance with standards in force (in Italy), solid fuel boilers with manual loading must be installed in systems fitted with “open” expansion vessels. For automatic loading, systems with closed vessels are permitted.

### 4.3. Chimney

The chimney plays a fundamental role in ensuring good boiler operation: the chimney must be impermeable and well insulated. Old or new chimneys not built in compliance with the above specifications can be used, however with special modifications. A metal flue needs to be entered inside the existing chimney, filling the space between the metal flue and the chimney with special insulation. Chimneys made from prefabricated blocks must have perfectly sealed joints to prevent condensate in the flue gas from fouling the walls due to absorption.

Construction of new chimneys must be based on an approved design, as required by the relevant standards in force.

In any case, the chimney must feature good draught, equal to at least 2 mm WC of negative pressure at the base when cold. Chimneys with insufficient draught will cause the boiler to shutdown when the system is not operating, with tar and condensate forming along the air inlet. Vice-versa, a chimney with excessive natural draught will cause problems of thermal inertia as well as high pellet consumption.

A draught register should always be installed so as to maintain constant negative pressure in the chimney. This will avoid any unwanted increases in heat output.

## 5. SY400 ELECTRONIC PANEL (CODE PEL0100DUO)

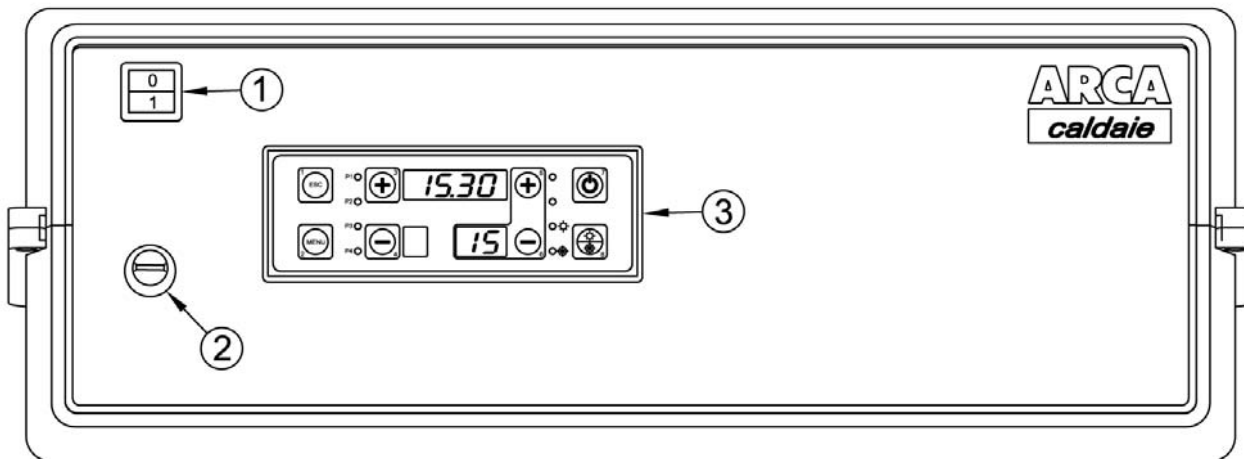

### Key:

1. Main switch
2. Safety thermostat
3. Display keypad

### 5.1. Display

The figure below shows the control unit operator panel, with the key to the functions of each component:

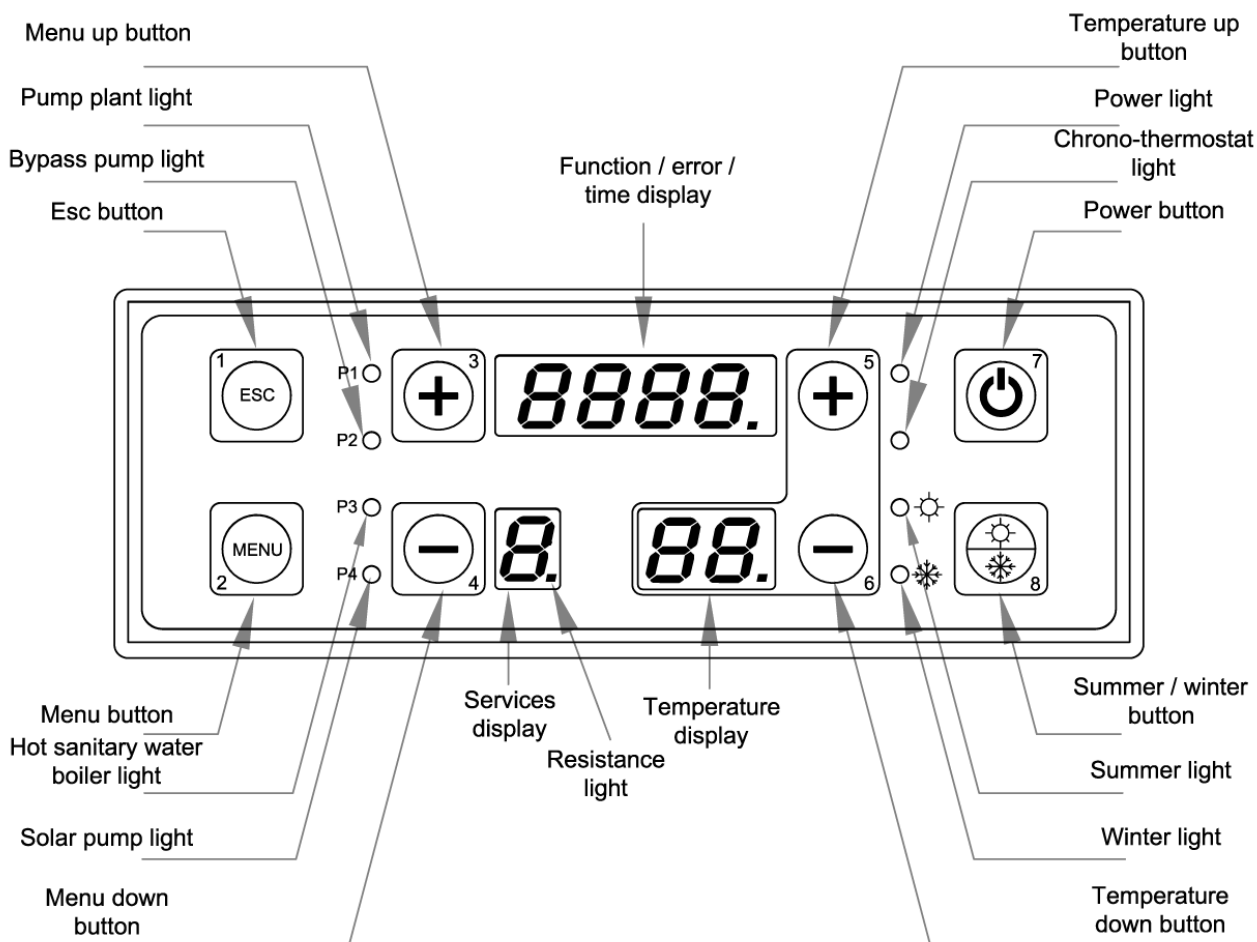

## 5.2. Electronic board (inside the panel)

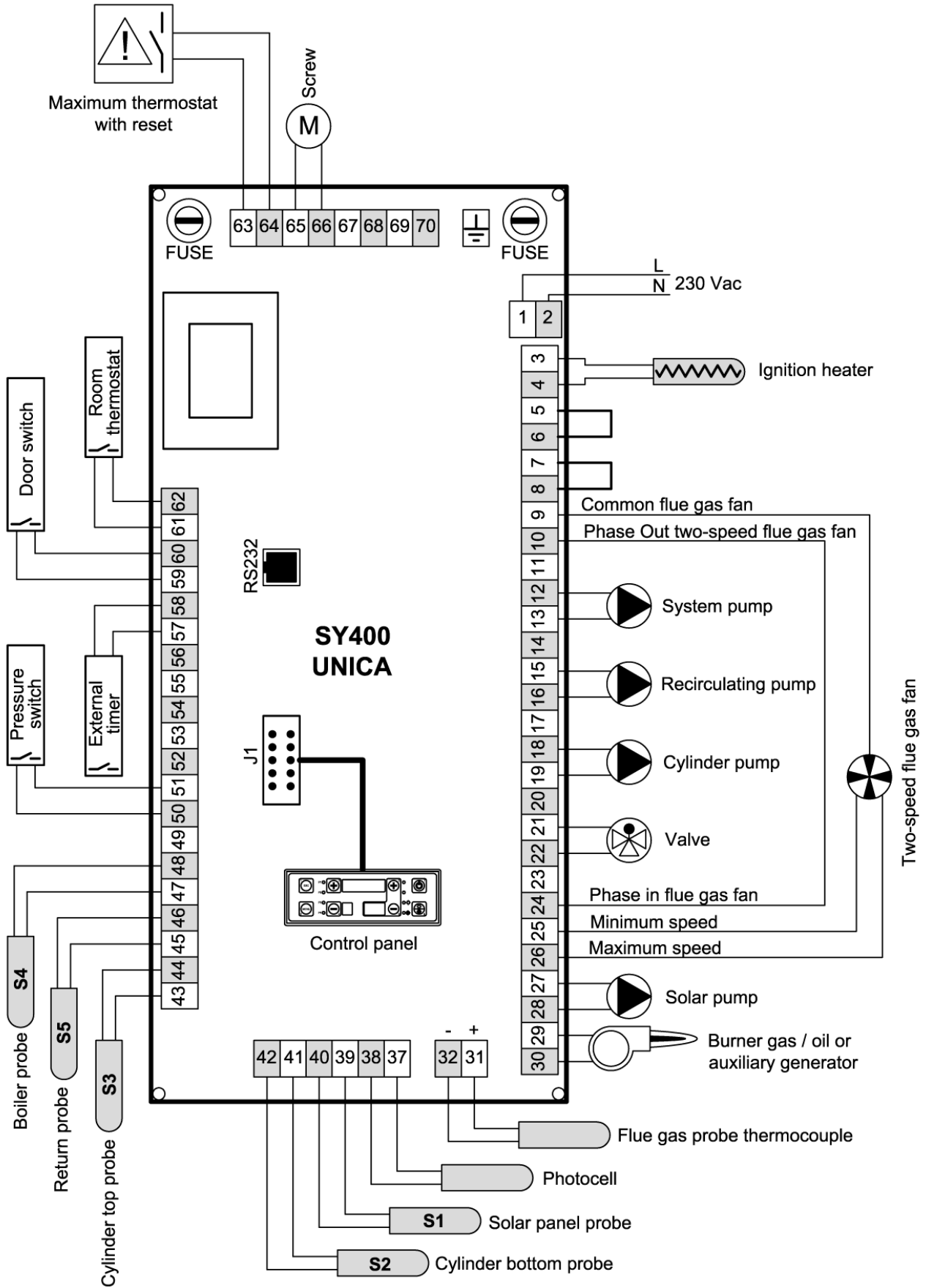



### 5.3. Probe connections

For correct boiler operation the water temperature probes and safety thermostat sensor must be positioned correctly. The control unit comes pre-wired with the outlet probe S4 - 3 m of cable (terminals 47, 48 page 15), the return probe S5 - 3 m of cable (terminals 45, 46 page 15) and the safety thermostat (terminals 63, 64 page 15).

These must be positioned as shown in the following figure:

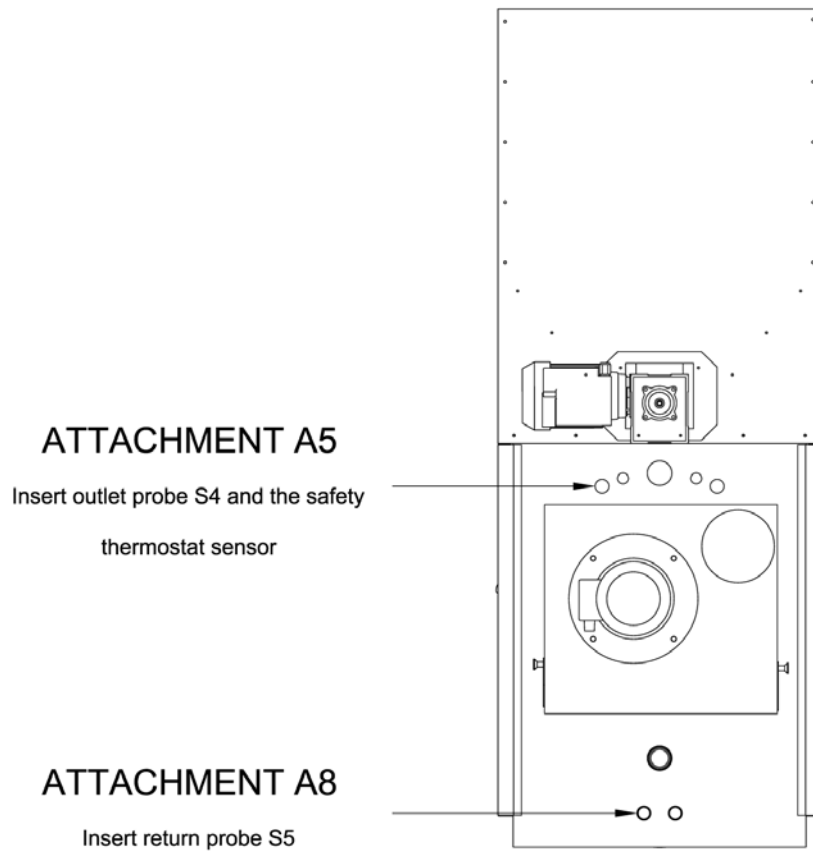

### 5.4. Flue gas probe connection

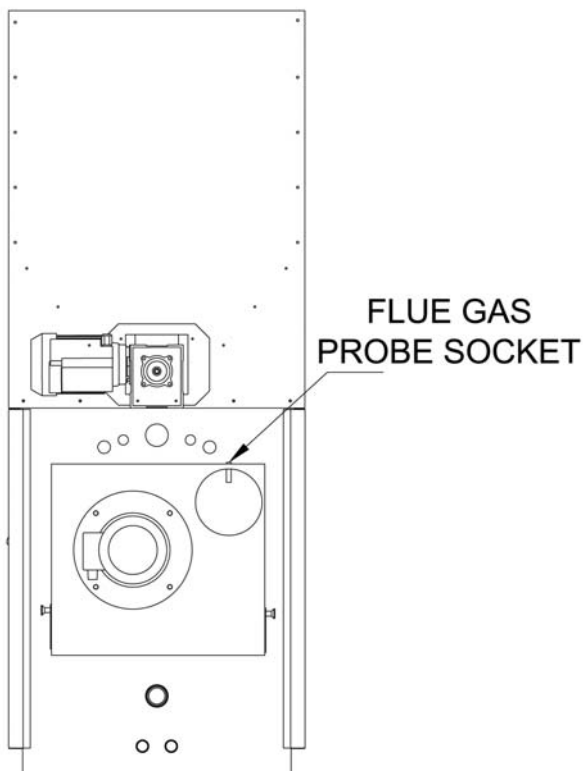

The flue gas probe is already wired on the electronic board to terminals 31 - 32, as shown in the figure on page 15.

This must be fitted at the rear of the boiler: near the chimney attachment is a socket for inserting the probe.

## 5.5. Terminal block wiring connections

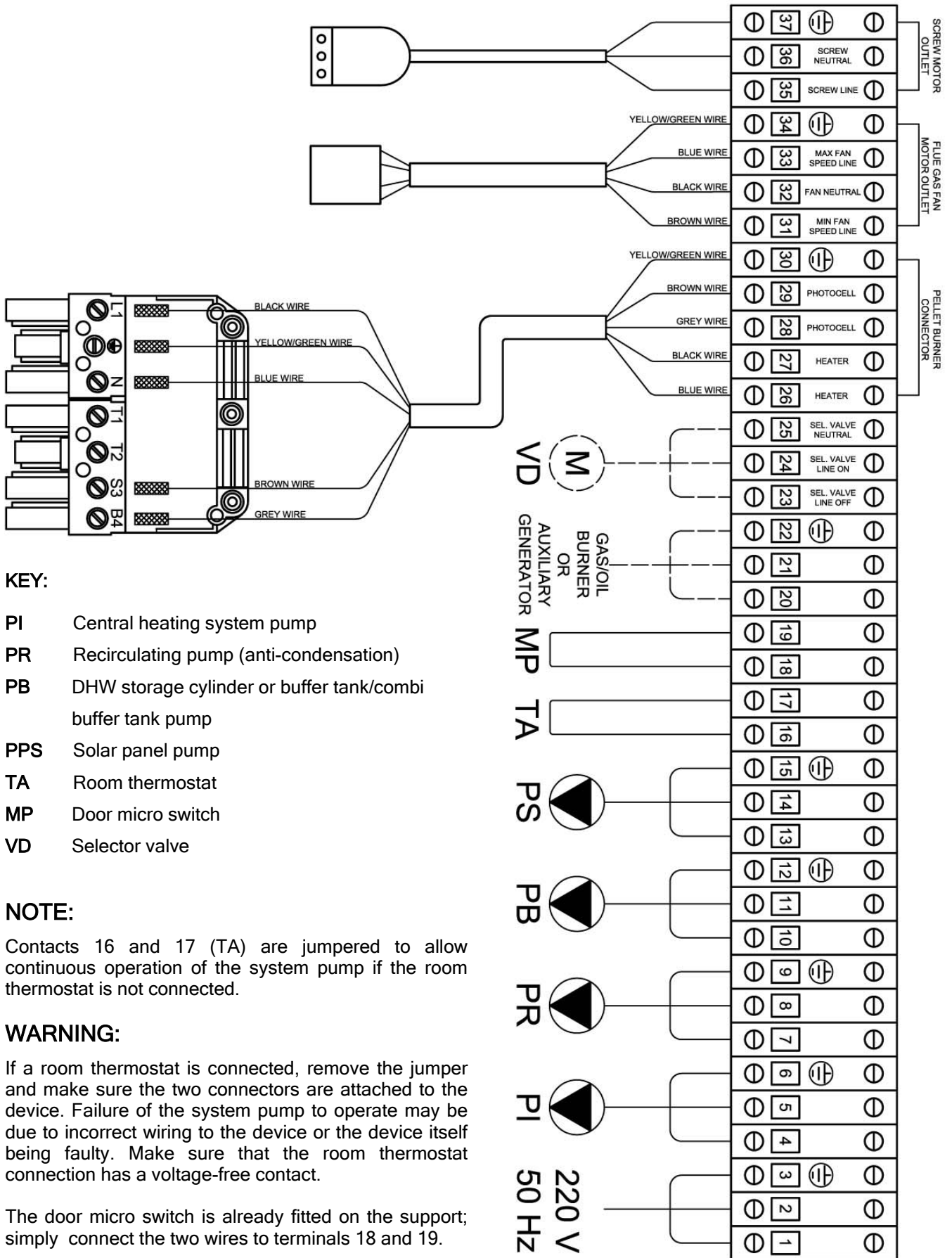

## 6. COMMISSIONING AND OPERATION

Before starting the boiler, check that:

- a) the system is full of water and vented
- b) any on-off devices are open and that the pumps are not blocked; moreover:
  - Before performing any maintenance always disconnect power to the boiler and wait for the appliance to reach room temperature.
  - Never drain the water from the system unless absolutely unavoidable.
  - Periodically check operation of the flue gas exhaust device and/or flue.
  - Do not use flammable substances (petrol, alcohol, solvents, etc.) to clean the boiler.

**Warning:** for models with separate fuel containers, where the fuel is supplied by a hopper, when starting the first time the screw must be completely filled with fuel.

### 6.1. Boiler in standby

When the boiler is at rest the fan is off and the top display shows the time. The bottom right display always shows the outlet temperature.

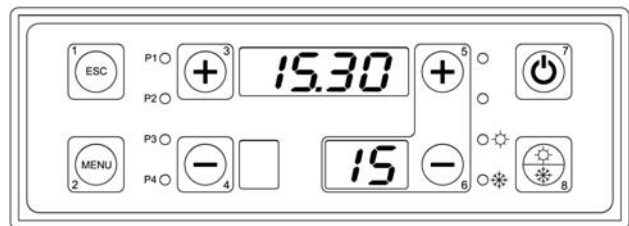

### 6.2. Boiler ignition

Press button 7 for around 5 seconds to start the ignition cycle.

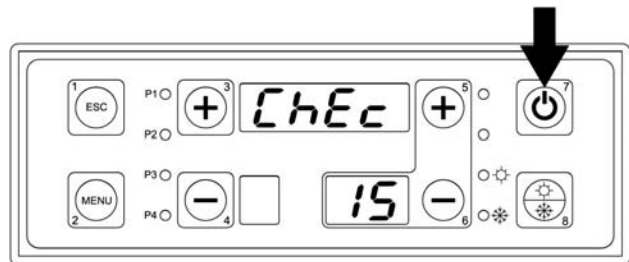

When the operating cycle starts the top display shows "CHEC" and the fan operates at maximum speed to vent the pellet burner draught tube. This stage lasts 2 minutes.

At the end of the two minutes the top display shows "ACC".

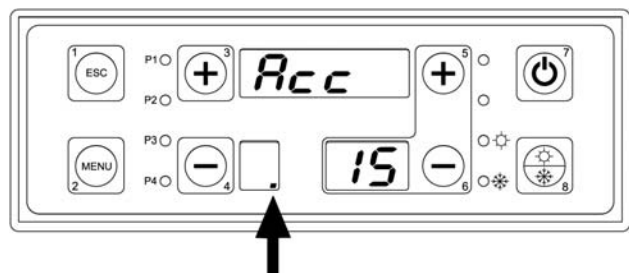

This stage involves pre-heating by the ignition heater, as indicated by a point on the bottom left display. It lasts 2 minutes and the fan switches to minimum speed.

Once the pre-heating stage has ended the control unit activates the screw motor to pre-load pellets into the burner and ignite the flame. When the screw is operating, the bottom left display shows a clockwise movement.

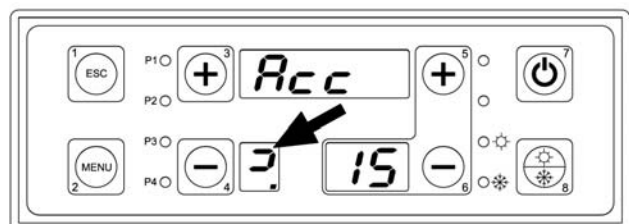

Ignition time may vary due to the different types of pellets available on the market (the maximum duration allowed for each attempt is set at 10 minutes).

### 6.3. Flame stabilisation

Once the flame has ignited the flame stabilisation stage begins (fixed duration 3 minutes) and the top display shows “STB”.

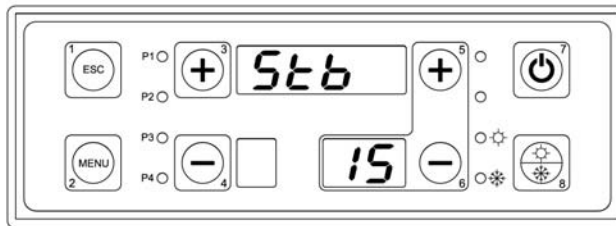

In this stage the heater is off, the fan operates at maximum speed and the screw motor starts running to load pellets into the burner, based on the parameters set on the electronic board.

### 6.4. Normal operation

Once the stabilisation stage has ended normal operation begins and the top display shows “NOR”, indicating normal boiler output; in this stage the fan operates at maximum speed.

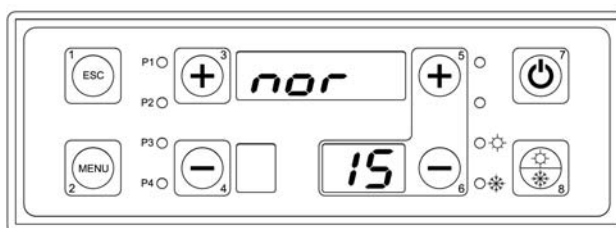

### 6.5. Boiler temperature setting

To set the boiler operating temperature use buttons 5 and 6. The bottom display will show the set temperature.

**WARNING:** the operating temperature setting must be within a minimum and maximum value, i.e. cannot be below 65°C nor exceed 80°C.

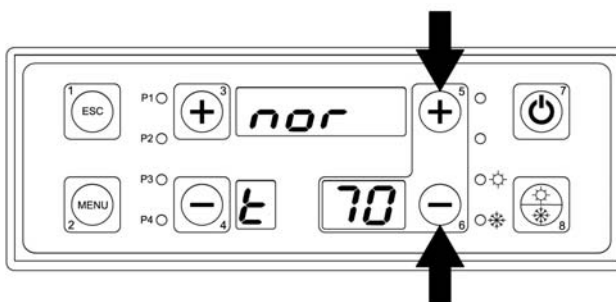

### 6.6. Modulation

On reaching the set temperature and more precisely 5°C below the operating temperature, the top display will show the text “MOD” indicating modulating operation; in this stage the fan operates at minimum speed. This message may also be shown when the boiler starts modulating operation due to excessive flue gas temperature (maximum setting 190°C).

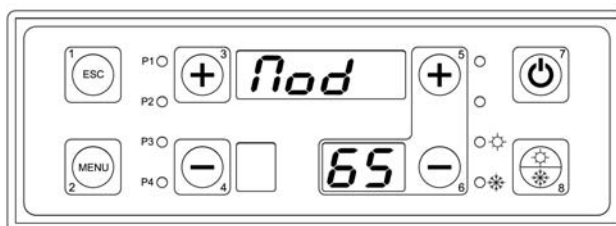

### 6.7. Maintenance

Once time the set temperature has been reached the top display will show “MAN”, indicating the temperature maintenance stage; in this stage the boiler starts the cycle to extinguish the flame by stopping the screw motor. Once the flue gas temperature falls below 120°C and flame brightness falls below the value 15 the fan starts a post-ventilation cycle lasting 2 minutes and then stops. When the temperature falls 5°C below the set value the boiler will start again, repeating the ignition cycle.

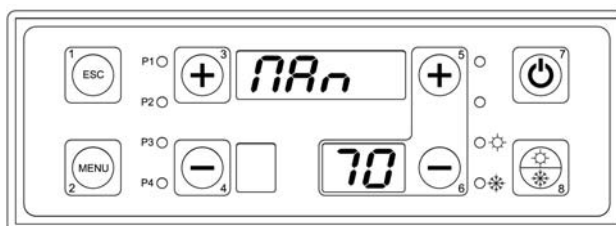

## 6.8. Total shutdown

The boiler can be shut down at any time by pressing button 7 for 5 seconds.

In this way, the boiler remains off even when the outlet temperature decreases.

The total shutdown stage also waits for the flue gas temperature to fall below 120°C and flame brightness to fall below the value 15, then the 2 minute post-ventilation cycle is completed before shutting down completely.

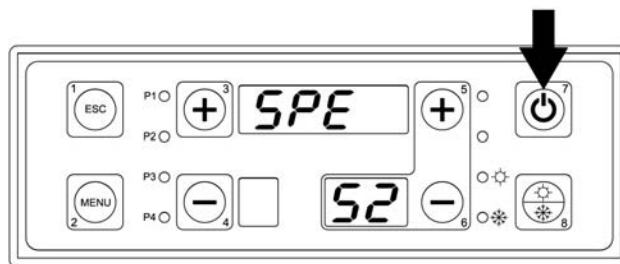

**WARNING:** only use button 7 to switch the boiler off, never power the appliance down using green main switch on the electronic panel.

## 7. USER MENU

This can be accessed by pressing the MENU button (2) on the front panel.

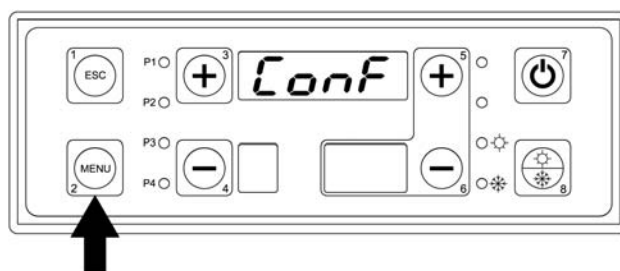

Procedure for accessing the menu and the submenus:

- Enter the user menu by pressing **MENU** (2)
- Once having entered the menu, the 4-digit top display shows the names of the various submenus
- To scroll the submenus forwards and backwards press the menu up (3) or menu down (4) button
- To enter a submenu press **MENU** (2)
- To exit a submenu and return to the previous menu, press **ESC** (1)
- The menus can be exited manually by pressing **ESC** (1) from the main menu, or automatically when no button is pressed for 40 seconds.
- Below is the list of all the submenus in the user menu and their functions.

List of user menus and submenus:

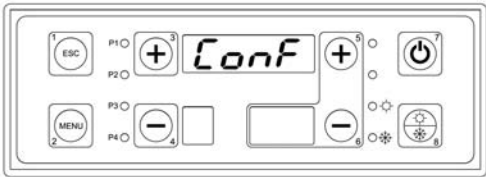
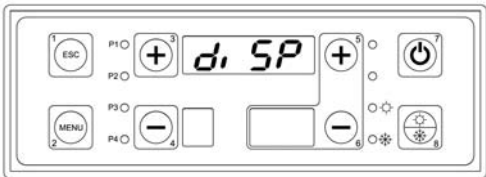
ITEM NO.	USER MENU	DESCRIPTION
1		WATER CIRCUIT CONFIGURATION
2		DISPLAY

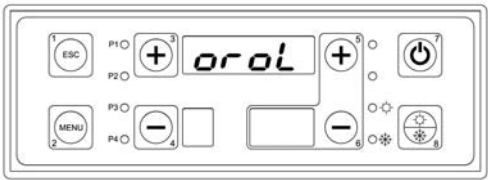
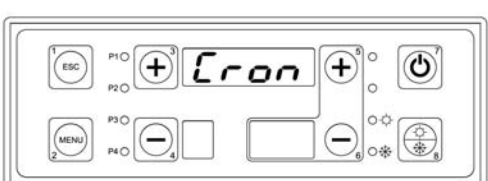
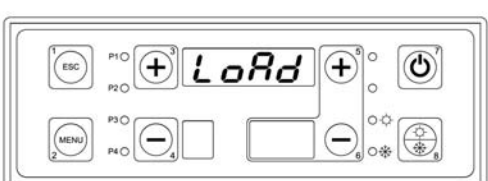
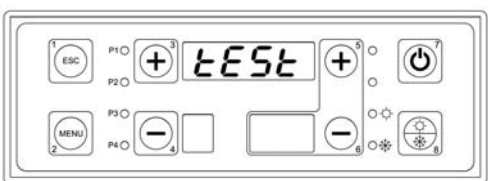
3		CLOCK
4		BOILER PROGRAMMING BY TIMER THERMOSTAT
5		MANUAL SCREW LOADING WITH EMPTY TANK
6		TEST 220 V OUTPUTS

### 7.1. Water circuit configuration menu (enable probes)

Depending on the type of water circuit connected to the boiler, the temperature probes need to be enabled for managing the pump electrical signals.

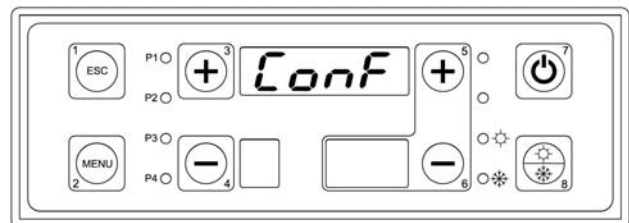

PROCEED AS FOLLOWS:



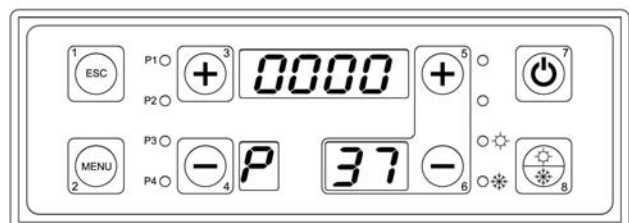

- 1) Press **MENU**.
- 2) The top display shows **CONF**.
- 3) Press **MENU**.

4) The bottom display shows the parameter being set, while the top display shows its value, which by default is always 0000.



- 5) Press **MENU**.
- 6) The value 0000 flashes; use button 3 to set the value as shown in the table below.
- 7) Once the value has been set, press **MENU** to confirm the changes.
- 8) Press **ESC** to exit or wait 40 seconds to automatically exit the menu.

The following table indicates the values for enabling the probes based on the type of water circuit used:

System configuration [P37]	Description	Water probes used	Pumps used
	Heating only	Boiler outlet probe <b>S4</b> Boiler return probe <b>S5</b>	System pump ( <b>PI</b> ) Anti-condensation pump ( <b>PR</b> )
	Heating + DHW storage cylinder	Boiler outlet probe <b>S4</b> Boiler return probe <b>S5</b> DHW cylinder top probe <b>S3</b>	System pump ( <b>PI</b> ) Anti-condensation pump ( <b>PR</b> ) DHW cylinder pump ( <b>PB</b> )
	Heating + Buffer tank / Combi buffer tank	Boiler outlet probe <b>S4</b> Boiler return probe <b>S5</b> Buffer tank top probe <b>S3</b> Buffer tank bottom probe <b>S2</b>	System pump ( <b>PI</b> ) Anti-condensation pump ( <b>PR</b> ) Buffer tank pump ( <b>PB</b> )
	Heating + DHW storage cylinder + Solar panels	Boiler outlet probe <b>S4</b> Boiler return probe <b>S5</b> DHW cylinder top probe <b>S3</b> DHW cylinder bottom probe <b>S2</b> Solar panel probe <b>S1</b>	System pump ( <b>PI</b> ) Anti-condensation pump ( <b>PR</b> ) DHW cylinder pump ( <b>PB</b> ) Solar panel pump ( <b>PS</b> )
	Heating + Buffer tank + Solar panels	Boiler outlet probe <b>S4</b> Boiler return probe <b>S5</b> Buffer tank top probe <b>S3</b> Buffer tank bottom probe <b>S2</b> Solar panel probe <b>S1</b>	System pump ( <b>PI</b> ) Anti-condensation pump ( <b>PR</b> ) Buffer tank pump ( <b>PB</b> ) Solar panel pump ( <b>PS</b> )

## 7.2. Display menu (display probe readings)

The display menu shows the values read by the probes enabled on the control unit.  
The top display shows the value of the selected probe.  
The bottom display shows the code identifying the probe.

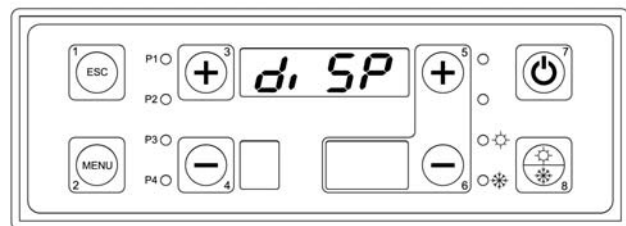

**PROCEED AS FOLLOWS:**





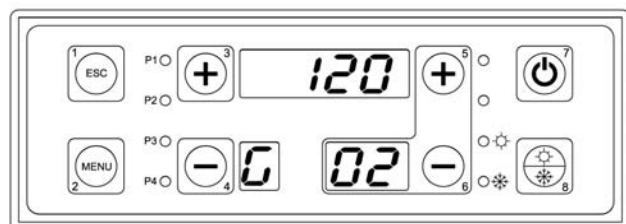







- 1) Press **MENU**.
- 2) Press button **3** repeatedly until the top display shows **DISP**.
- 3) Press **MENU**.

4) The bottom display shows the parameter being set, while the top display shows its value.







- 5) Scroll the parameters using buttons **3** and **4**.
- 6) Press **ESC** to exit or wait 40 seconds to automatically exit the menu.

The following table shows all the possible codes depending on which probes have been enabled:

ITEM NO.	DISPLAY	DESCRIPTION
1	 	<p align="center"><b>FLAME BRIGHTNESS</b> (always displayed)</p>
2	 	<p align="center"><b>FLUE GAS TEMPERATURE IN °C</b> (always displayed)</p>
3	 	<p align="center"><b>OUTLET WATER TEMPERATURE IN °C</b> (always displayed)</p>
4	 	<p align="center"><b>RETURN WATER TEMPERATURE IN °C</b> (always displayed)</p>
5	 	<p align="center"><b>CYLINDER / BUFFER TANK TOP TEMPERATURE IN °C</b> (only displayed if enabled)</p>
6	 	<p align="center"><b>CYLINDER / BUFFER TANK BOTTOM TEMPERATURE IN °C</b> (only displayed if enabled)</p>



7		<p><b>SOLAR PANEL TEMPERATURE IN °C</b> (only displayed if enabled)</p>
8		<p><b>WATER TEMPERATURE DIFFERENTIAL BETWEEN OUTLET AND RETURN IN °C</b> (always displayed)</p>
9		<p><b>TEMPERATURE DIFFERENTIAL BETWEEN SOLAR PANELS AND CYLINDER / BUFFER TANK BOTTOM IN °C</b> (only displayed if enabled)</p>
10		<p><b>BOARD PROGRAM VERSION</b> (always displayed)</p>

### 7.3. Clock menu

The clock menu is used to set the current time and day of the week.

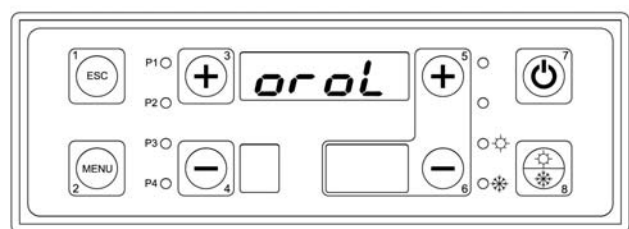

**PROCEED AS FOLLOWS:**

- 1) Press **MENU**.
- 2) Press button **3** repeatedly until the top display shows **OROL**.
- 3) Press **MENU**.

4) The bottom display shows the day of the week, while the top display shows the hours and minutes.

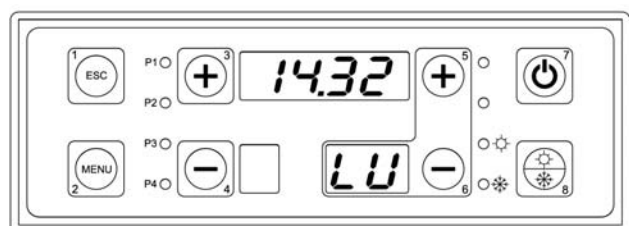

- 5) Press **MENU** (the hours value starts flashing).
- 6) Use buttons **3** and **4** to set the hours.

- 7) Press **MENU** (the minutes value starts flashing).
- 8) Use buttons **3** and **4** to set the minutes.
- 9) Press **MENU** (the day value starts flashing).
- 10) Use buttons **3** and **4** to set the day.
- 11) Press **MENU**.
- 12) Press **ESC** to exit or wait 40 seconds to automatically exit the menu.

#### 7.4. Timer thermostat programming menu

The timer thermostat menu is used to set a time program for automatically starting and stopping the boiler.

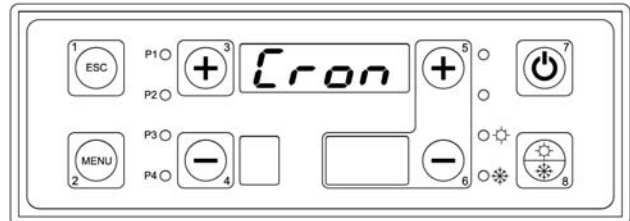

The timer thermostat can be programmed in different ways according to the requirements of the user.

The following programs are available:

Manual start/stop* using button 7.	
	<input type="checkbox"/> <input type="checkbox"/>
Daily programming.	
	<input type="checkbox"/> <input type="checkbox"/>
Weekly programming.	
	<input type="checkbox"/> <input type="checkbox"/>
Weekend programming.	
	<input type="checkbox"/> <input type="checkbox"/>

\* manual operation is set as default.

#### SELECTING THE TYPE OF PROGRAM:

- 1) Press **MENU**.
- 2) Press button **3** repeatedly until the top display shows **CRON**.
- 3) Press **MENU**.

- 4) The display shows **PROG**.

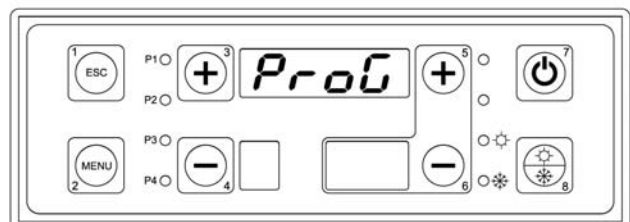

- 5) Press **MENU**.
- 6) The display shows **MAN**.
- 7) Press **MENU**.

NRn G, or SEtt F, SE



8) Use buttons 3 and 4 to set the type of program.

9) Press MENU to confirm.

### SETTING THE DAILY PROGRAM:

The DAILY program is used to set the boiler on / off times for the individual days of the week. For each day of the week there are 3 time bands available (each has an ON time and an OFF time).

The top display shows 4 dashes if programming is not enabled or displays the ON and OFF times if programming is enabled.

The ON light indicates the ON time, while the OFF light indicates the OFF time.

1) Press MENU.

2) Press button 3 repeatedly until the top display shows CRON.

3) Press MENU.

4) The display shows PROG.

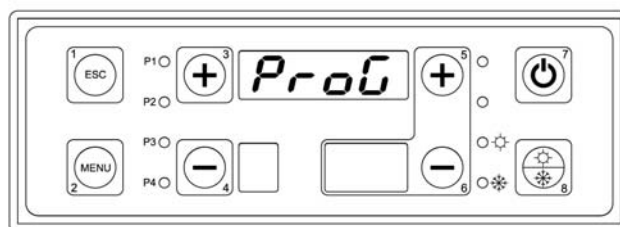

5) Press button 3 repeatedly until the top display shows GIOR.

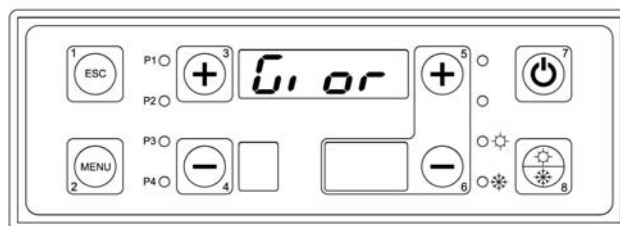

6) Press MENU.

7) The top display shows 4 dashes, the bottom right display shows the program number (from 1 to 3), the bottom right display shows the day in question (from Monday to Sunday) and the ON light comes on.

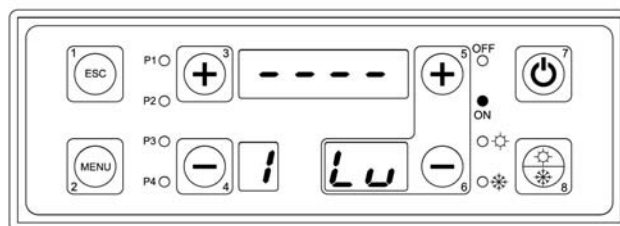

8) Enable the time band and clear the dashes by holding button 7 for 5 seconds. Set the ON time.

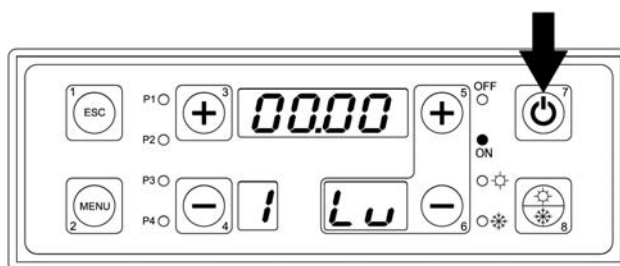

9) Press MENU.

10) Set the hours using buttons 3 and 4.

11) Confirm by pressing the MENU button..

12) Set the minutes using buttons 3 and 4.

13) Confirm by pressing the MENU button.

14) Repeat the same operations described above to set the OFF time.

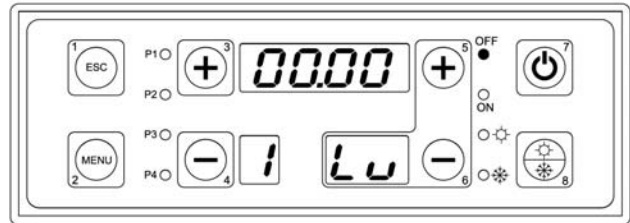

15) Press button 3 to set the second program or select the time band for the second day, third day, etc.

**SETTING THE WEEKLY PROGRAM:**

The WEEKLY program is used to set the same boiler on / off times for every day of the week. Three time bands are available (each has an ON time and an OFF time).

The top display shows 4 dashes if programming is not enabled or displays the ON and OFF times if programming is enabled.

The ON light indicates the ON time, while the OFF light indicates the OFF time.

- 1) Press MENU.
- 2) Press button 3 repeatedly until the top display shows CRON.
- 3) Press MENU.

4) The display shows PROG.

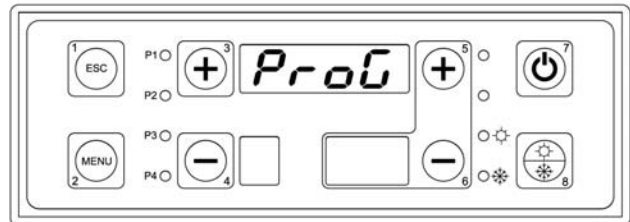

5) Press button 3 repeatedly until the top display shows SETT.

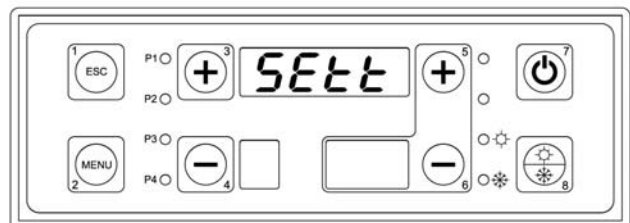

6) Press MENU.

7) The top display shows 4 dashes, the bottom right display shows the program number (from 1 to 3), the bottom right display shows LD indicating the days from Monday to Sunday. The ON light comes on.

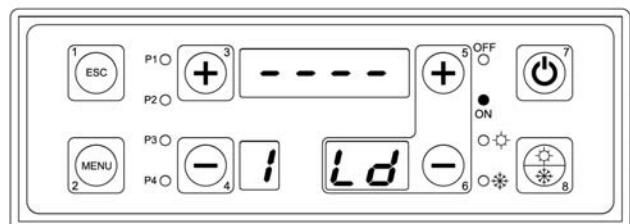

8) Enable the time band and clear the dashes by holding button 7 for 5 seconds. Set the ON time, which will be the same for all days from Monday to Sunday.

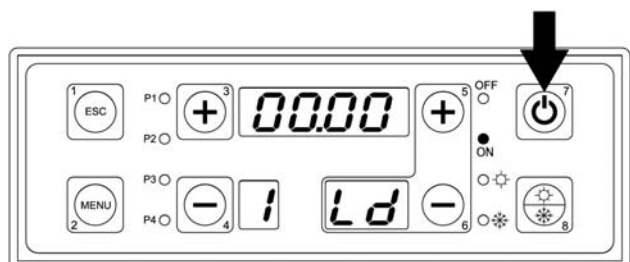

- 9) Press **MENU**.
- 10) Set the hours using buttons **3** and **4**.
- 11) Confirm by pressing the **MENU** button.
- 12) Set the minutes using buttons **3** and **4**.
- 13) Confirm by pressing the **MENU** button.

- 14) Repeat the same operations described above to set the OFF time.

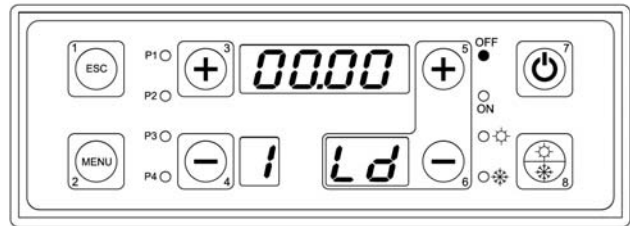

- 15) Press button 3 to set the second program or **ESC** to exit.

### SETTING THE WEEKEND PROGRAM:

The WEEKEND program is used to set the same boiler on / off times for every day from Monday to Friday and the same times for Saturday and Sunday. Three time bands are available (each has an ON time and an OFF time).

The top display shows 4 dashes if programming is not enabled or displays the ON and OFF times if programming is enabled.

The **ON** light indicates the ON time, while the **OFF** light indicates the OFF time.

- 1) Press **MENU**.
- 2) Press button **3** repeatedly until the top display shows **CRON**.
- 3) Press **MENU**.

- 4) The display shows **PROG**.

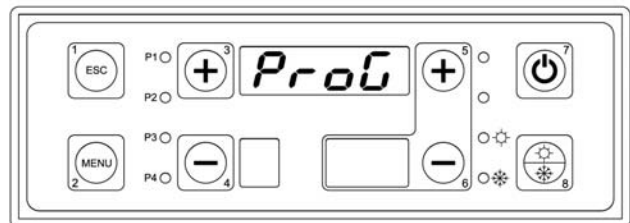

- 5) Press button **3** repeatedly until the top display shows **FISE**.

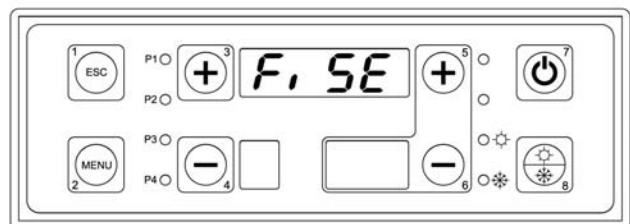

- 6) Press **MENU**.

- 7) The top display shows 4 dashes, the bottom right display shows the program number (from 1 to 3), the bottom right display shows LU, indicating the days from Monday to Friday. The **ON** light comes on.

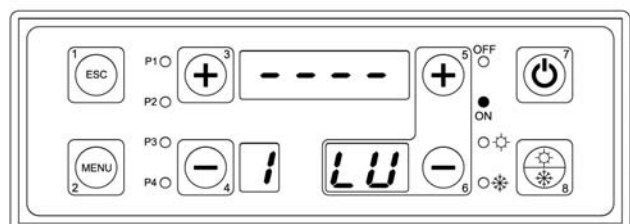

8) Enable the time band and clear the dashes by holding button 7 for 5 seconds.  
Set the ON time, which will be the same for all days from Monday to Friday.

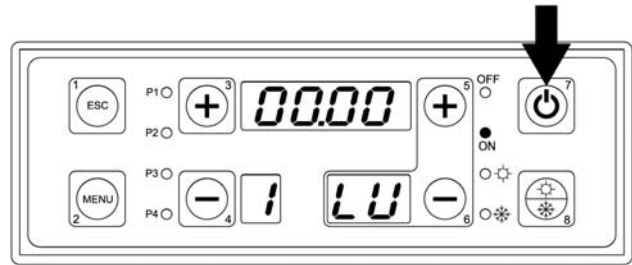

- 9) Press **MENU**.
- 10) Set the hours using buttons **3** and **4**.
- 11) Confirm by pressing the **MENU** button.
- 12) Set the minutes using buttons **3** and **4**.
- 13) Confirm by pressing the **MENU** button.

14) Repeat the same operations described above to set the OFF time.

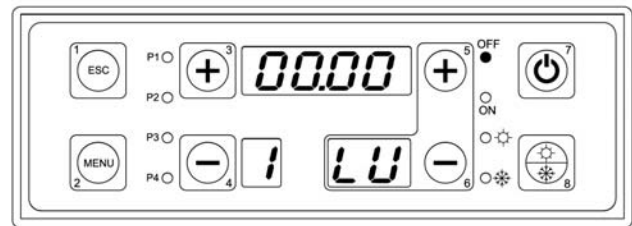

15) Press button 3 to set the second program or alternatively select the second time band for Saturday and Sunday.

16) The top display shows 4 dashes, the bottom right display shows the program number (from 1 to 3), the bottom right display shows SD, indicating Saturday and Sunday.  
The **ON** light comes on.

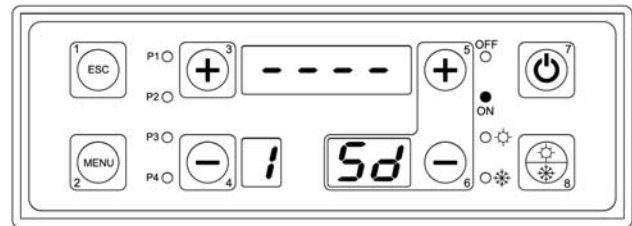

17) Enable the time band and clear the dashes by holding button 7 for 5 seconds.  
Set the ON time, which will be the same for Saturday and Sunday.

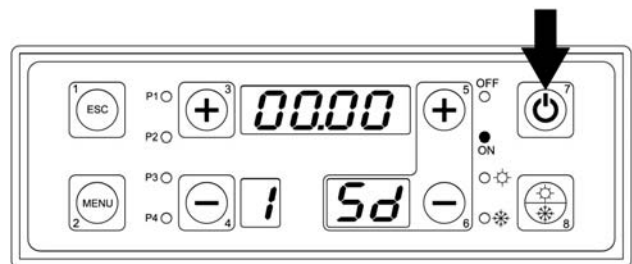

- 18) Press **MENU**.
- 19) Set the hours using buttons **3** and **4**.
- 20) Confirm by pressing the **MENU** button.
- 21) Set the minutes using buttons **3** and **4**.
- 22) Confirm by pressing the **MENU** button.

23) Repeat the same operations described above to set the OFF time.

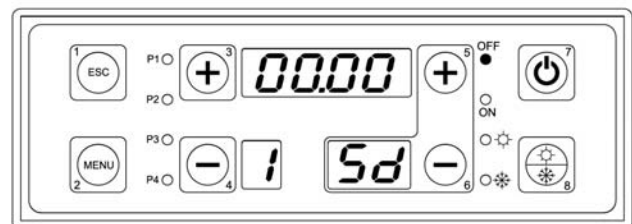

24) Press button **3** to set the second program or **ESC** to exit..

## 7.5. Manual screw loading menu

In **OFF** mode this is used to manually load the screw by completely filling the pipe that houses the screw.

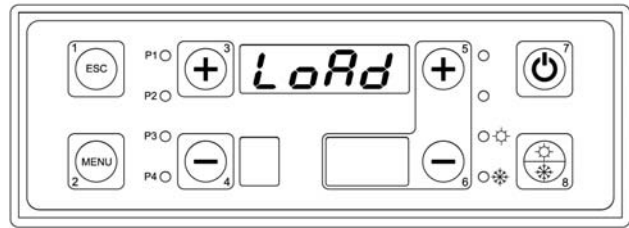

**PROCEED AS FOLLOWS:**

- 1) Press **MENU**.
- 2) Press button **3** repeatedly until the top display shows **LOAD**.
- 3) Press **MENU**.

- 4) **OFF** flashes on the top display.

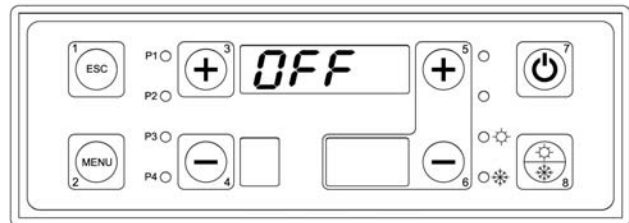

- 5) Press button **3** or **4** to switch the screw **ON**. If **ESC** is not pressed, the screw automatically switches **OFF** after 40 seconds.

## 7.6. Test menu

This menu is used to test the individual outputs on the board (and consequently the connected loads) when the boiler is **OFF**.

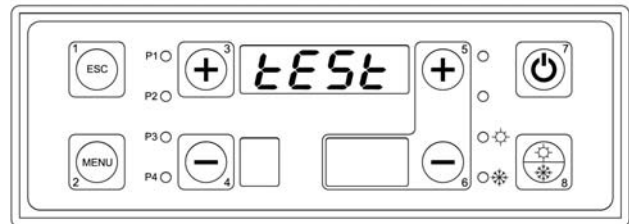

**PROCEED AS FOLLOWS:**

- 1) Make sure the boiler is **OFF**.
- 2) Press **MENU**.
- 3) Press button **3** repeatedly until the top display shows **TEST**.
- 4) Press **MENU**.

- 5) The top display shows the parameter being tested, **FUM1**. **FUM1** is the boiler flue gas fan.

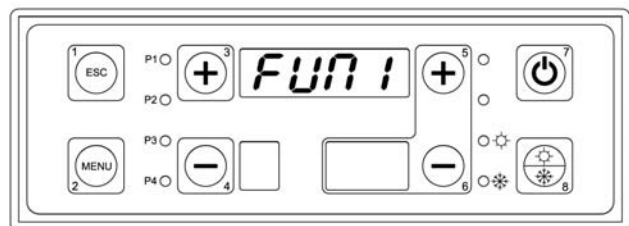

- 6) Press **MENU** (the top display shows 0000 flashing).
- 7) Use buttons **3** and **4** to set the value as follows:
  - o 0000 fan **OFF**.
  - o 0001 fan at **minimum** speed.
  - o 0099 fan at **maximum** speed.
- 8) Press **ESC**.
- 9) Press button **3**.

10) The top display shows the parameter being tested, **FUM2**.

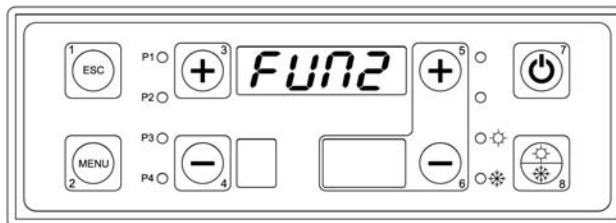

\* Parameter **FUM2** is not used for any application and consequently does not need to be tested.

11) Press button 3.

12) The top display shows the parameter being tested, **COCL**. COCL is the pellet feed screw motor.

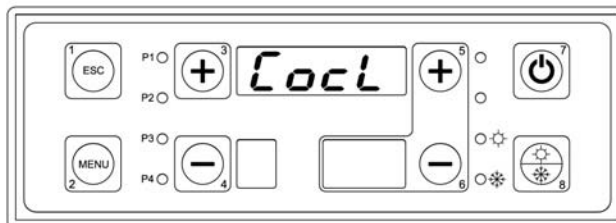

\* Parameter **COCL** should only be tested if its function is featured, i.e. on DUO TECH or GRANOLA AUTOMATIC / MANUAL boilers.

13) Press button 3.

14) The top display shows the parameter being tested, **CAND**. CAND is the pellet ignition heater.

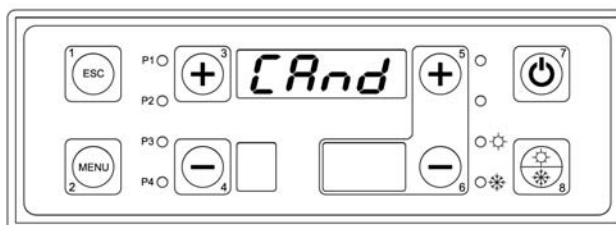

\* Parameter **CAND** should only be tested if its function is featured, i.e. on DUO TECH or GRANOLA AUTOMATIC boilers.

15) Press button 3.

16) The top display shows the parameter being tested, **POMP**. POMP is the system pump (PI).

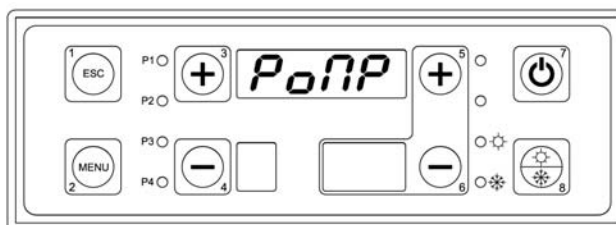

17) Press **MENU** (the top display shows OFF flashing).

18) Use buttons 3 and 4 to set the value to ON and check the system pump (PI) output at terminals 4 - 5 - 6 on the terminal block.

19) Press **ESC**.

20) Press button 3.

21) The top display shows the parameter being tested, **RICI**. RICI is the recirculating or anti-condensation pump (PR).

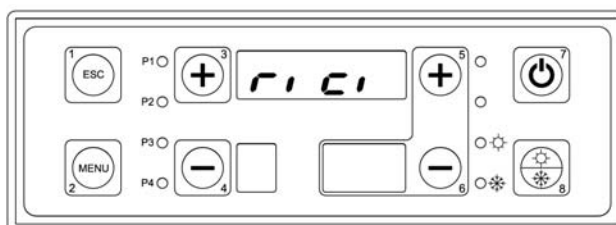

22) Press **MENU** (the top display shows OFF flashing).

23) Use buttons 3 and 4 to set the value to ON and check the recirculating pump (PR) output at terminals 7 - 8 - 9 on the terminal block.

24) Press **ESC**.

25) Press button 3.



26) The top display shows the parameter being tested, **BOIL**. BOIL is the storage cylinder pump (PB).

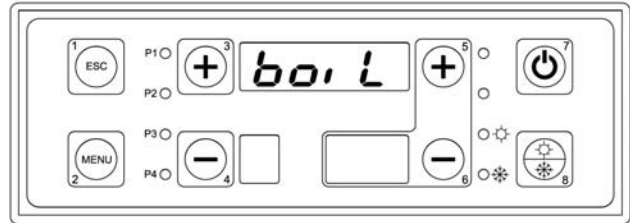

27) Press **MENU** (the top display shows OFF flashing).

28) Use buttons **3** and **4** to set the value to ON and check the storage cylinder pump (PB) output at terminals 10 - 11 - 12 on the terminal block.

29) Press **ESC**.

30) Press button **3**.

31) The top display shows the parameter being tested, **SOLA**. SOLA is the solar panel pump (PS).

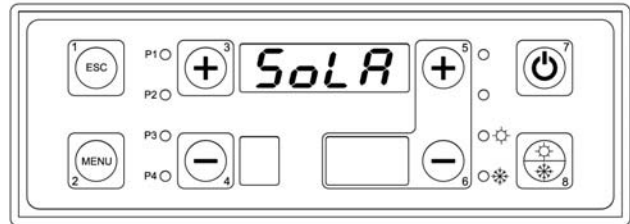

32) Press **MENU** (the top display shows OFF flashing).

33) Use buttons **3** and **4** to set the value to ON and check the solar panel pump (PS) output at terminals 13 - 14 - 15 on the terminal block.

34) Press **ESC**.

35) Press button **3**.

36) The top display shows the parameter being tested, **VALV**. VALV is the selector valve (VD).

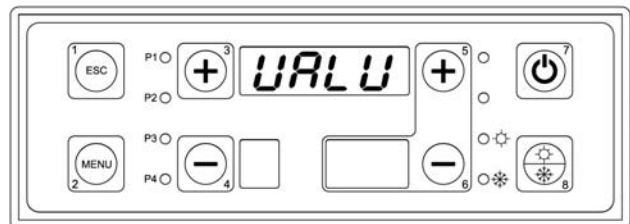

37) Press **MENU** (the top display shows OFF flashing).

38) Use buttons **3** and **4** to set the value to ON and check the selector valve (VD) output at terminals 23 - 24 - 25 on the terminal block.

\* Parameter VALV should only be tested if its function is featured, i.e. on ASPIRO - REGOVENT COMBI boilers.

39) Press **ESC**.

40) Press button **3**.

41) The top display shows the parameter being tested, **BRUC**. BRUC is the gas / oil burner in combi boilers.

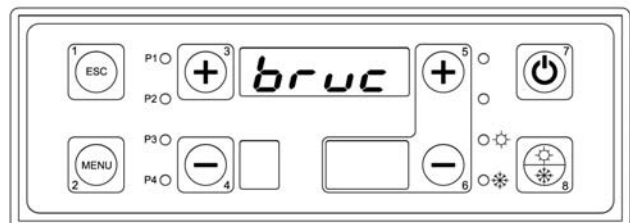

41) Press **MENU** (the top display shows OFF flashing).

42) Use buttons **3** and **4** to set the value to ON and check the gas / oil burner output at terminals 20 - 21 - 22 on the terminal block.

\* Parameter BRUC should only be tested if its function is featured, i.e. on ASPIRO - REGOVENT COMBI boilers.

43) Press **ESC**.

## 7.7. Summer / winter operation

This temperature control function allows differentiated management of the boiler water in the summer and winter. The function can be managed from the control panel by pressing the summer / winter button (11) for 5 seconds.



**WINTER POSITION** The system pump **PI** is enabled for operation.



**SUMMER POSITION** The system pump **PI** is not enabled for operation. Only the storage cylinder/combi buffer tank pump will be enabled if configured in the system.

## 8. WATER CIRCUIT DIAGRAMS

All the water circuit diagrams shown in this booklet are purely indicative, and must be approved by a heating system designer. ARCA s.r.l. is not liable for any damage to things, people or animals due to incorrect system design. For any diagrams not explicitly illustrated in this booklet, contact the ARCA technical department. The warranty will not cover any systems that are not commissioned in compliance with specifications or without authorisation.

### Nota:

Correct boiler operation requires installation of the recirculating pump to prevent temperature stratification in the boiler.

**The warranty is void if the recirculating pump is not installed.**

### 8.1. Example diagrams for heating-only system with open vessel

The heating-only system consists of the following parts:

1. **Boiler outlet probe (S4):** this is located in the socket near the boiler outlet (attachment A6) and its reading is used to change operating mode and enable operation of the pumps.
2. **Boiler return probe (S5):** this is located in the socket near the boiler return (attachment A7) and is used for operation of the recirculating or anti-condensation pump (PR).
3. **System pump (PI):** this is enabled for operation above the value of **TH-SYSTEM-PUMP [A01]**, however it's effectively activated based on the signal from the room thermostat. This always operates, i.e. ignores the room thermostat, in the event of a frost alarm (outlet water temperature less than the value of **TH-BOILER-ICE [A00]**) or anti-inertia operation (outlet water temperature greater than the value of **TH-BOILER-SAFE [A04]**).
4. **Recirculating or anti-condensation pump (PR):** this is enabled for operation above the value of **TH-RECIRCPUMP [A14]**, however it's only activated when the outlet water temperature exceeds the return temperature by a delta equal to the value of parameter **RECIRCULATION DIFFERENTIAL [d00]** in the protected menu. This always operates in the event of a frost alarm (outlet water temperature less than the value of **TH-BOILER-ICE [A00]**) or anti-inertia operation (outlet water temperature greater than the value of **TH-BOILER-SAFE [A04]**).

### 8.1.1. Example diagram for heating-only with open vessel

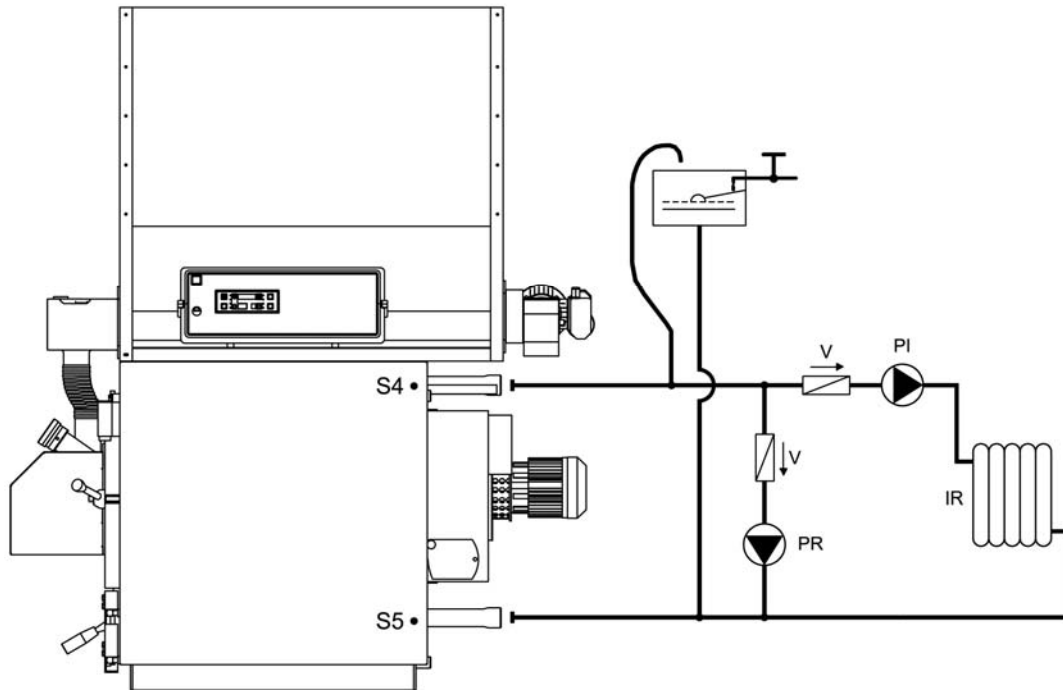

Key:

PI	System pump	V	Check valve
PR	Recirculating pump	S4	Boiler outlet probe
IR	Central heating system	S5	Boiler return probe

### 8.1.2. Example diagram for heating-only with open vessel with mixing valve

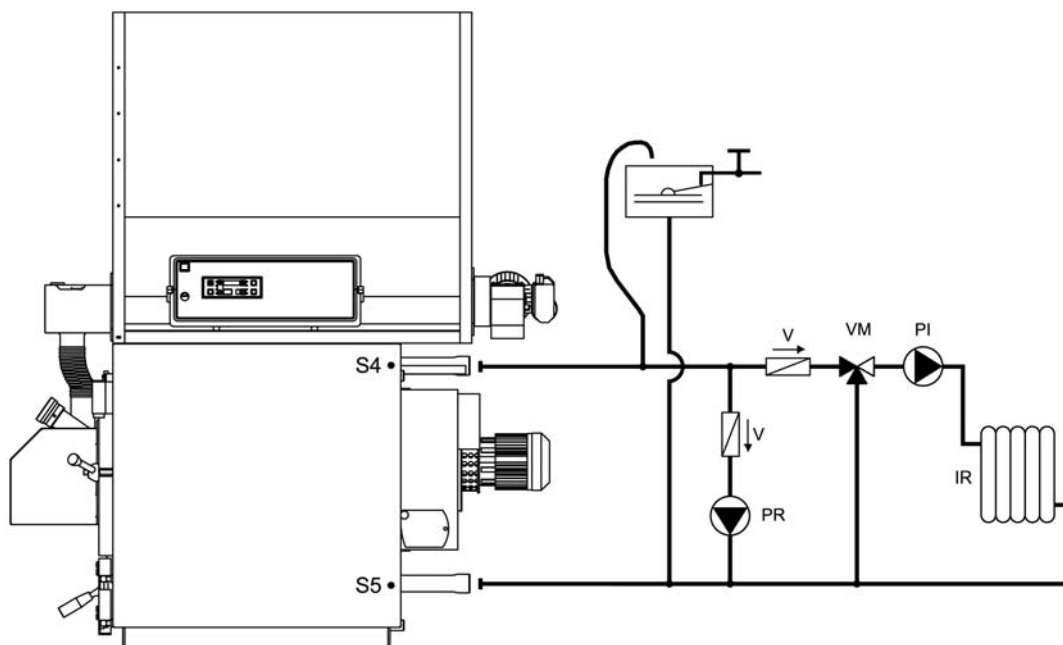

Key:

PI	System pump	V	Check valve
PR	Recirculating pump	S4	Boiler outlet probe
IR	Central heating system	S5	Boiler return probe
VM	Mixing valve		

### 8.1.3. Example diagram for heating-only with plate heat exchanger

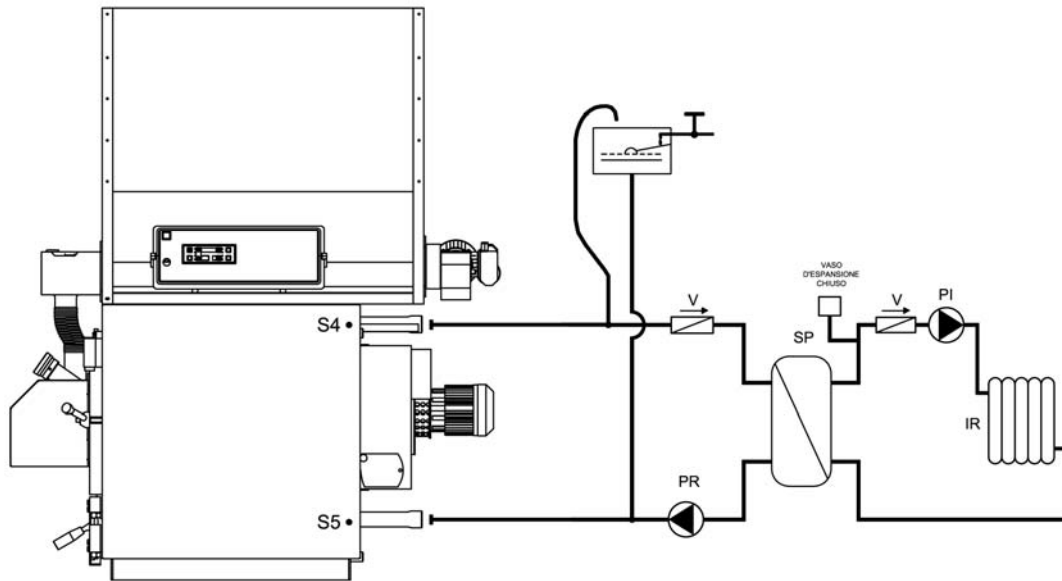

Key:

PI	System pump	V	Check valve
PR	Recirculating pump	S4	Boiler outlet probe
IR	Central heating system	S5	Boiler return probe
SP	Plate heat exchanger		

### 8.2. Example diagrams for heating system with domestic hot water storage cylinder

The heating system with domestic hot water storage cylinder consists of the following parts:

- Boiler outlet probe (S4):** this is located in the socket near the boiler outlet (attachment A6) and its reading is used to change operating mode and enable operation of the pumps.
- Boiler return probe (S5):** this is located in the socket near the boiler return (attachment A7) and is used for operation of the recirculation or anti-condensation pump (PR).
- Storage cylinder top probe (S3):** this is located in the socket at the top of the domestic hot water storage cylinder and is used for management of the storage cylinder pump (PB).
- Storage cylinder bottom probe (S2):** this is located in the socket at the bottom of the domestic hot water storage cylinder and is used for management of the solar panel pump (PS).
- Solar panel probe (S1):** this is located on the outlet of the solar panel manifold and is used for management of the solar panel pump (PS).
- System pump (PI):** this is enabled for operation above the value of TH-SYSTEM-PUMP [A01] with the cylinder pump off, however it's effectively activated based on the signal from the room thermostat. This always operates, i.e. ignores the room thermostat, in the event of a frost alarm (outlet water temperature less than the value of TH-BOILER-ICE [A00]) or anti-inertia operation (outlet water temperature greater than the value of TH-BOILER-SAFE [A04]).
- Recirculating or anti-condensation pump (PR):** this is enabled for operation above the value of TH-RECIRC-PUMP [A14], however it's only activated when the outlet water temperature exceeds the return temperature by a delta equal to the value of parameter RECIRCULATION DIFFERENTIAL [d00] in the protected menu. This always operates in the event of a frost alarm (outlet water temperature less than the value of TH-BOILER-ICE [A00]) or anti-inertia operation (outlet water temperature greater than the value of TH-BOILER-SAFE [A04]).
- Storage cylinder pump (PB):** this is enabled for operation above the value of TH-CYLINDER-PUMP [A15], however it's effectively activated only when the temperature at the top of the cylinder is below the value of TH-DHWCYLINDER [A32]. It stops when the water temperature at the top of the cylinder reaches the above thermostat value. This always operates, i.e. ignores the room thermostat, in the event of a frost alarm (outlet water temperature less than the value of TH-BOILER-ICE [A00]) or anti-inertia operation (outlet water temperature greater than the value of TH-BOILER-SAFE [A04]).

9. **Solar panel pump (PS):** this is activated if the water temperature in the solar panel manifold exceeds the temperature at the bottom of the cylinder by a delta equal to the value of parameter **SOLAR DIFFERENTIAL [d16]** in the protected menu. If the water temperature at the top of the cylinder reaches the value of thermostat **TH-CYLINDER-SAFE [A35]**, the pump will stop for safety reasons. In the event of a solar panel frost alarm (panel water temperature less than the value of thermostat **TH-SOLAR-ICE [A48]**) the pump will be activated intermittently with off times equal to the value of parameter **TIME SOLAR ICE OFF [t37]** and on times equal to **TIME SOLAR ICE ON [t36]**.

### 8.2.1. Example diagram for heating with domestic hot water storage cylinder

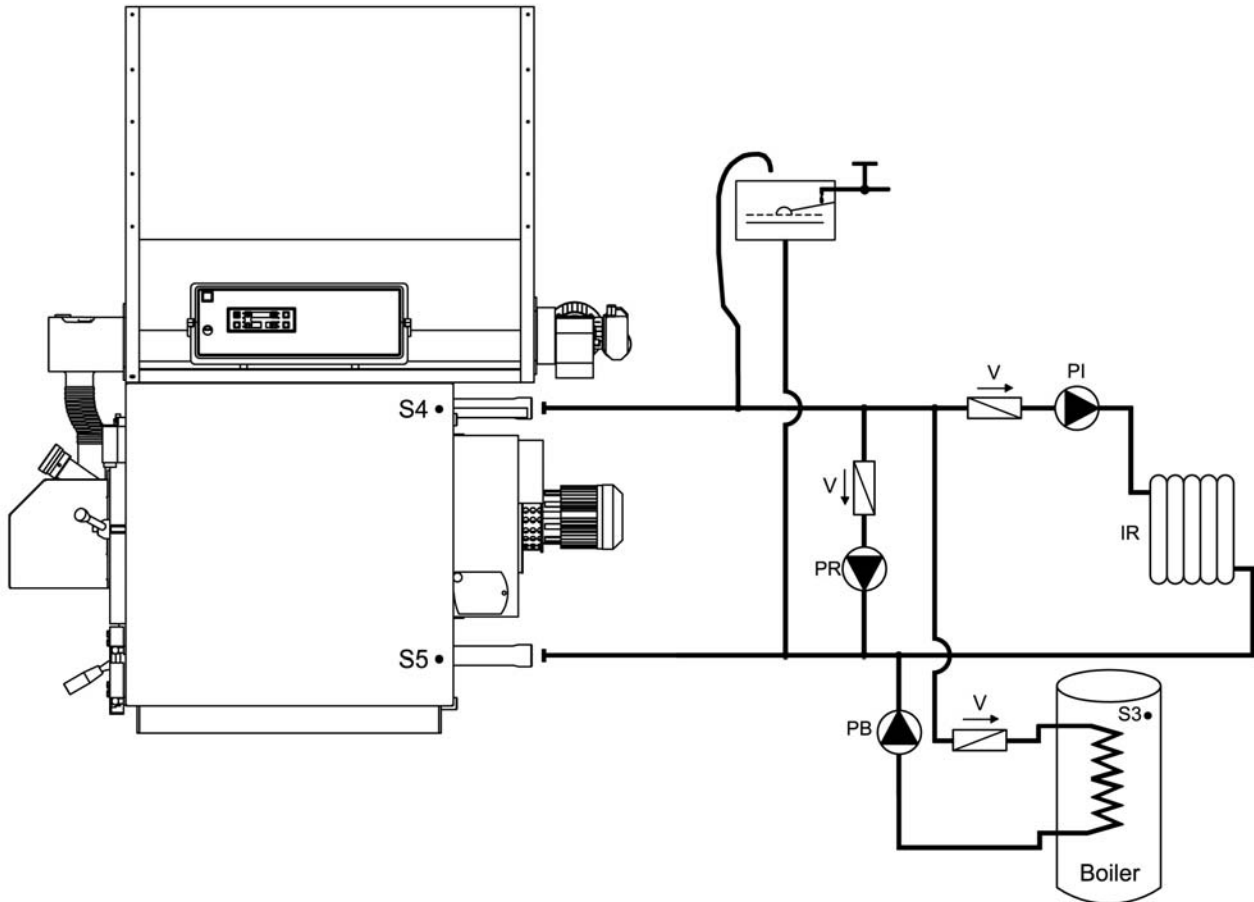

Key:

PI	System pump	V	Check valve
PR	Recirculating pump	S4	Boiler outlet probe
IR	Central heating system	S5	Boiler return probe
PB	DHW storage cylinder pump	S3	Storage cylinder top probe

### 8.2.2. Example diagram for heating with two-coil DHW storage cylinder and solar panels

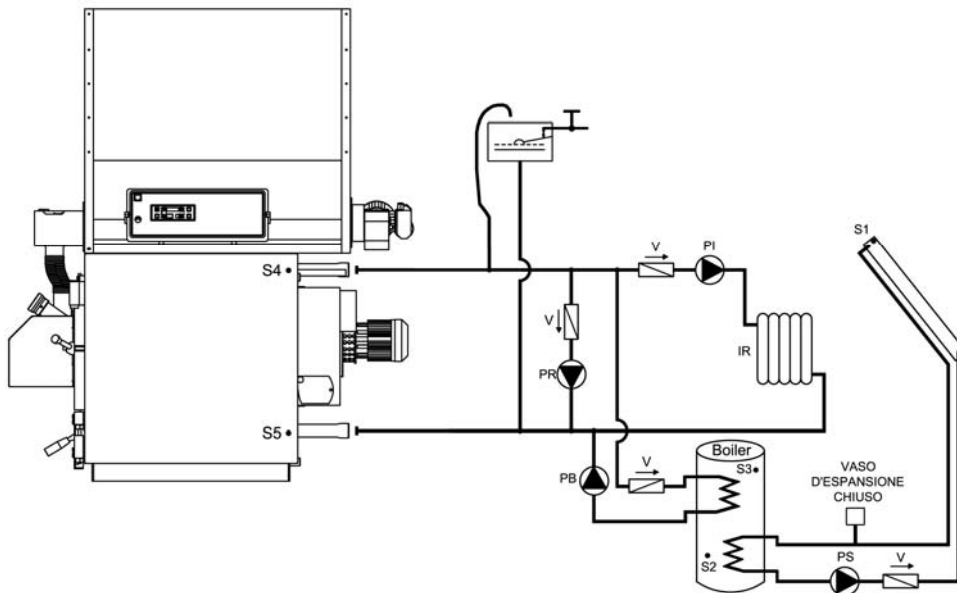

Key:

PI	System pump	S1	Solar panel probe
PR	Recirculating pump	S2	Storage cylinder bottom probe
PB	DHW storage cylinder pump	S3	Storage cylinder top probe
PS	Solar panel pump	S4	Boiler outlet probe
IR	Central heating system	S5	Boiler return probe
V	Check valve		

### 8.2.3. Example diagram for heating with closed vessel, plate heat exchanger, two-coil DHW storage cylinder and solar panels

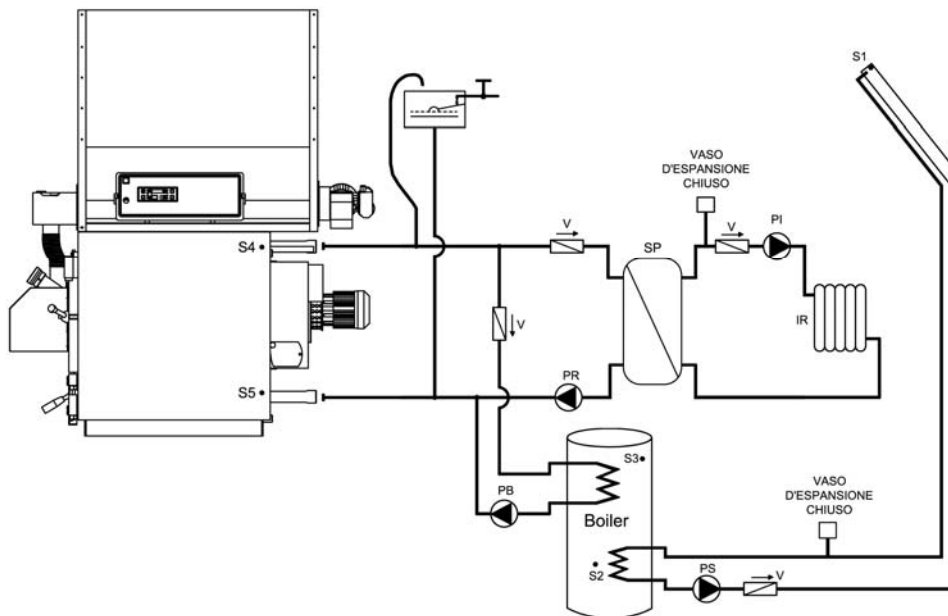

Key:

PI	System pump	S1	Solar panel probe
PR	Recirculating pump	S2	Storage cylinder bottom probe
PB	DHW storage cylinder pump	S3	Storage cylinder top probe
PS	Solar panel pump	S4	Boiler outlet probe
IR	Central heating system	S5	Boiler return probe
V	Check valve	SP	Plate heat exchanger

### 8.3. Example diagrams for heating system with buffer tank or combi buffer tank

The heating system with buffer tank or combi buffer tank consists of the following parts:

1. **Boiler outlet probe (S4):** this is located in the socket near the boiler outlet (attachment A6) and its reading is used to change operating mode and enable operation of the pumps.
2. **Boiler return probe (S5):** this is located in the socket near the boiler return (attachment A7) and is used for operation of the recirculation or anti-condensation pump (PR).
3. **Buffer tank top probe (S3):** this is located in the socket at the top of the buffer tank and is used for management of the buffer tank pump (PB) and the system pump (PI).
4. **Buffer tank bottom probe (S2):** this is located in the socket at the bottom of the buffer tank and is used for management of the buffer tank pump (PB) and the solar panel pump (PS).
5. **Solar panel probe (S1):** this is located on the outlet of the solar panel manifold and is used for management of the solar panel pump (PS).
6. **System pump (PI):** this is enabled for operation above the value of **TH-BUFFERSYSTEM-PUMP [A34]**, however it's effectively activated based on the signal from the room thermostat. This always operates, i.e. ignores the room thermostat, in the event of a frost alarm (outlet water temperature less than the value of **TH-BOILER-ICE [A00]**) or anti-inertia operation (outlet water temperature greater than the value of **TH-BOILER-SAFE [A04]**).
7. **Recirculating or anti-condensation pump (PR):** this is enabled for operation above the value of **TH-RECIRC-PUMP [A14]**, however it's only activated when the outlet water temperature exceeds the return temperature by a delta equal to the value of parameter **RECIRCULATION DIFFERENTIAL [d00]** in the protected menu. This always operates in the event of a frost alarm (outlet water temperature less than the value of **TH-BOILER-ICE [A00]**) or anti-inertia operation (outlet water temperature greater than the value of **TH-BOILER-SAFE [A04]**).
8. **Buffer tank pump (PB):** this is enabled for operation above the value of **TH-CYLINDER-PUMP [A15]**, however it's only activated when the temperature at the top of the buffer tank is below the value of **TH-PUFFER-ON [A33]**. It stops when the water temperature at the bottom of the buffer tank reaches the value of **TH-PUFFER-OFF [A48]**. This always operates, i.e. ignores the room thermostat, in the event of a frost alarm (outlet water temperature less than the thermostat **TH-BOILER-ICE [A00]**) or anti-inertia operation (outlet water temperature greater than the value of **TH-BOILER-SAFE [A04]**).
9. **Solar panel pump (PS):** this is activated if the water temperature in the solar panel manifold exceeds the temperature at the bottom of the cylinder by a delta equal to the value of parameter **SOLAR DIFFERENTIAL [d16]** in the protected menu. If the water temperature at the top of the cylinder reaches the value of thermostat **TH-CYLINDER-SAFE [A35]**, the pump will stop for safety reasons. In the event of a solar panel frost alarm (panel water temperature less than the value of thermostat **TH-SOLAR-ICE [A48]**) the pump will be activated intermittently with off times equal to the value of parameter **TIME SOLAR ICE OFF [t37]** and on times equal to **TIME SOLAR ICE ON [t36]**.

### 8.3.1. Example diagram for heating with combi buffer tank and solar panels

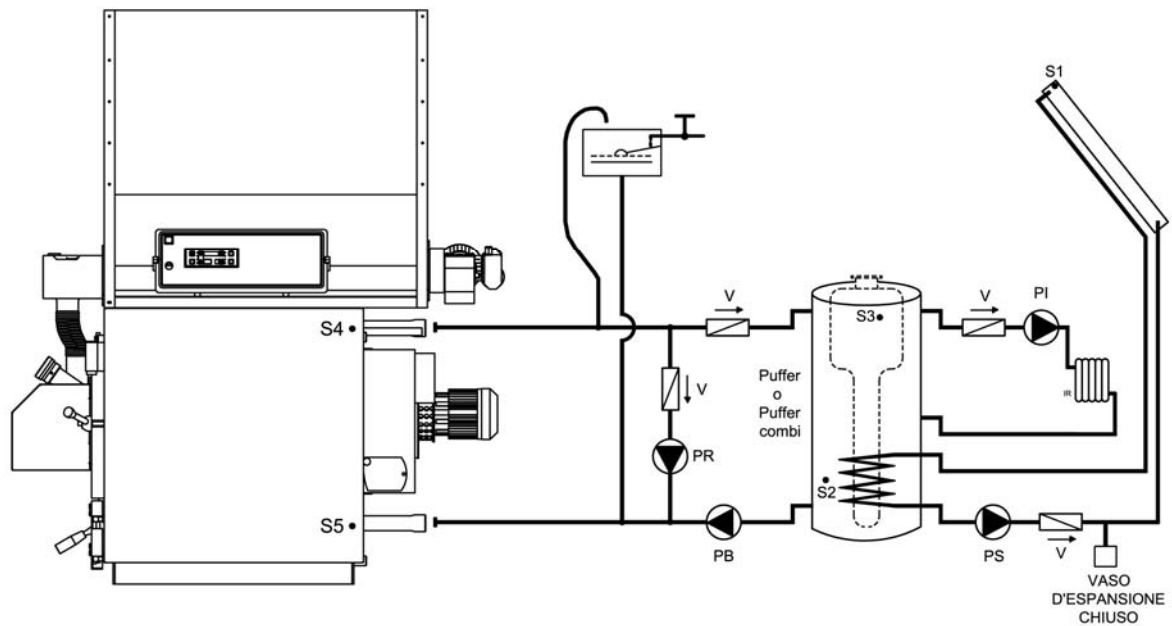

Key:

PI	System pump	S1	Solar panel probe
PR	Recirculating pump	S2	Storage cylinder bottom probe
PB	DHW storage cylinder pump	S3	Storage cylinder top probe
PS	Solar panel pump	S4	Boiler outlet probe
IR	Central heating system	S5	Boiler return probe
V	Check valve		

### 8.3.2. Example diagram for heating with closed vessel, plate heat exchanger, combi buffer tank and solar panels

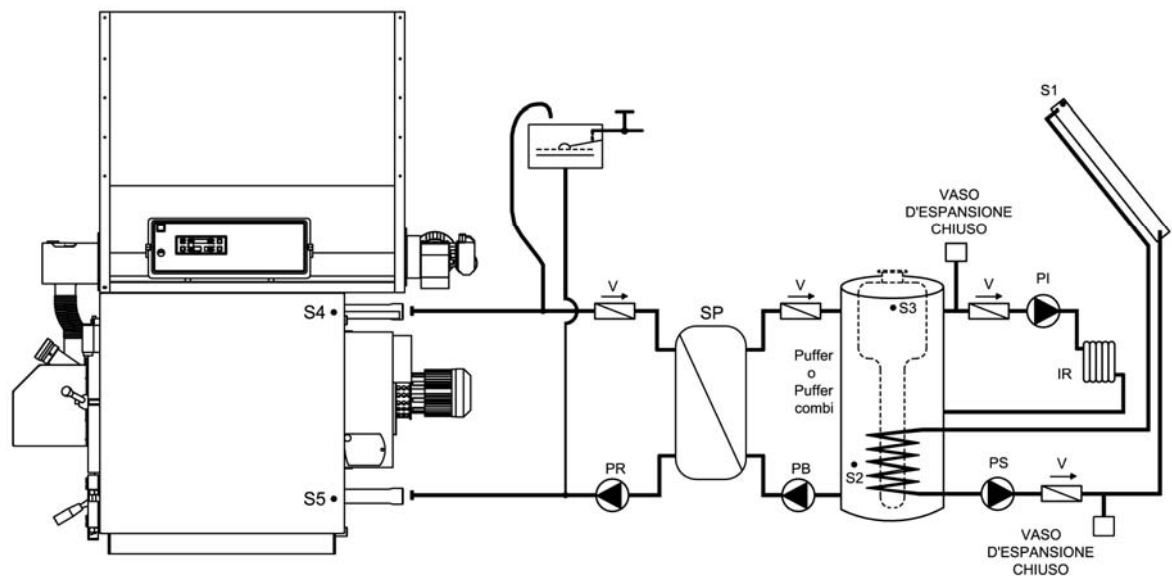

Key:

PI	System pump	S1	Solar panel probe
PR	Recirculating pump	S2	Storage cylinder bottom probe
PB	DHW storage cylinder pump	S3	Storage cylinder top probe
PS	Solar panel pump	S4	Boiler outlet probe
IR	Central heating system	S5	Boiler return probe
V	Check valve	SP	Plate heat exchanger



## 8.4. Example diagrams for heating system with domestic hot water storage cylinder and buffer tank

The heating system with domestic hot water storage cylinder and buffer tank consists of the following parts:

1. **Boiler outlet probe (S4):** this is located in the socket near the boiler outlet (attachment A6) and its reading is used to change operating mode and enable operation of the pumps.
2. **Boiler return probe (S5):** this is located in the socket near the boiler return (attachment A7) and is used for operation of the recirculation or anti-condensation pump (PR).
3. **DHW probe storage cylinder top (S3):** this is located in the socket at the top of the domestic hot water storage cylinder and is used for management of the storage cylinder pump (PB).
4. **DHW probe storage cylinder bottom (S2):** this is located in the socket at the bottom of the domestic hot water storage cylinder and is used for management of the solar panel pump (PS).
5. **Solar panel probe (S1):** this is located on the outlet of the solar panel manifold and is used for management of the solar panel pump (PS).
6. **Buffer tank pump (PI):** this is enabled for operation above the value of **TH-SYSTEM-PUMP [A01]** with the cylinder pump off. It always operates in the event of a frost alarm (outlet water temperature less than the value of **TH-BOILER-ICE [A00]**) or anti-inertia operation (outlet water temperature greater than the value of **TH-BOILER-SAFE [A04]**).
7. **Recirculating or anti-condensation pump (PR):** this is enabled for operation above the value of **TH-RECIRCPUMP [A14]**, however it's only activated when the outlet water temperature exceeds the return temperature by a delta equal to the value of parameter **RECIRCULATION DIFFERENTIAL [d00]** in the protected menu. This always operates in the event of a frost alarm (outlet water temperature less than the value of **TH-BOILER-ICE [A00]**) or anti-inertia operation (outlet water temperature greater than the value of **TH-BOILER-SAFE [A04]**).
8. **Storage cylinder pump (PB):** this is enabled for operation above the value of **TH-CYLINDER-PUMP [A15]**, however it's effectively activated only when the temperature at the top of the cylinder is below the value of **TH-DHWCYLINDER [A32]**. It stops when the water temperature at the top of the cylinder reaches the above thermostat value. It always operates in the event of a frost alarm (outlet water temperature less than the value of **TH-BOILER-ICE [A00]**) or anti-inertia operation (outlet water temperature greater than the value of **TH-BOILER-SAFE [A04]**).
9. **Solar panel pump (PS):** this is activated if the water temperature in the solar panel manifold exceeds the temperature at the bottom of the cylinder by a delta equal to the value of parameter **SOLAR DIFFERENTIAL [d16]** in the protected menu. If the water temperature at the top of the cylinder reaches the value of thermostat **TH-CYLINDER-SAFE [A35]**, the pump will stop for safety reasons. In the event of a solar panel frost alarm (panel water temperature less than the value of thermostat **TH-SOLAR-ICE [A48]**) the pump will be activated intermittently with off times equal to the value of parameter **TIME SOLAR ICE OFF [t37]** and on times equal to **TIME SOLAR ICE ON [t36]**.

### 8.4.1. Example diagram for heating with buffer tank and two-coil DHW storage cylinder and solar panels

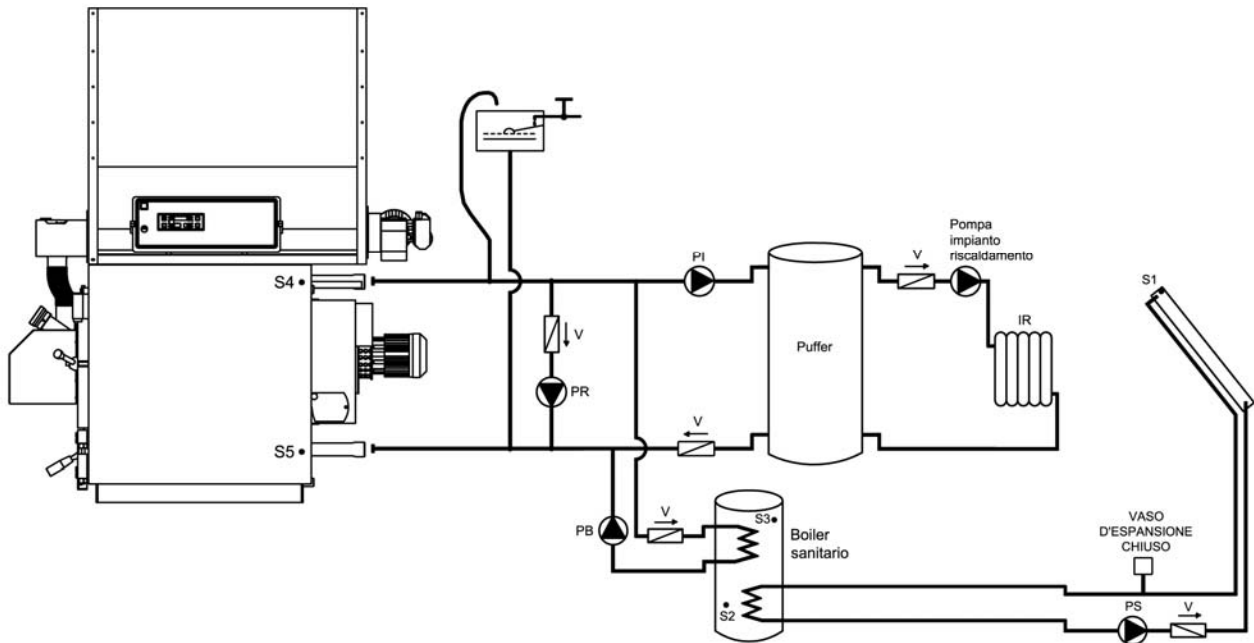

Key:

PI	System pump	S1	Solar panel probe
PR	Recirculating pump	S2	Storage cylinder bottom probe
PB	DHW storage cylinder pump	S3	Storage cylinder top probe
PS	Solar panel pump	S4	Boiler outlet probe
IR	Central heating system	S5	Boiler return probe
V	Check valve		

#### **WARNING.**

This type of system uses the system pump (PI) to fill the buffer tank, while the “heating system pump” indicated on the diagram is the pump that fills the home’s central heating system. This pump must therefore be controlled from outside of the boiler panel and connected directly to the room thermostat. The boiler panel electrical output at terminals 16 and 17 must be jumpered to enable operation of the buffer tank fill pump according to the boiler temperature parameters.

A minimum buffer tank temperature thermostat (set to 50 / 60°C) should be installed at the top of the buffer tank and connected directly to the room thermostat, so as to activate the “heating system pump” only if the buffer tank has reached the temperature set on the thermostat.

## 9. CENTRAL HEATING SYSTEM CONNECTIONS TO “N” ZONES

Arca S.r.l. supplies a control unit for managing 4 zones as an accessory (code SCH0005C). This is connected to the SY400 boiler panel.

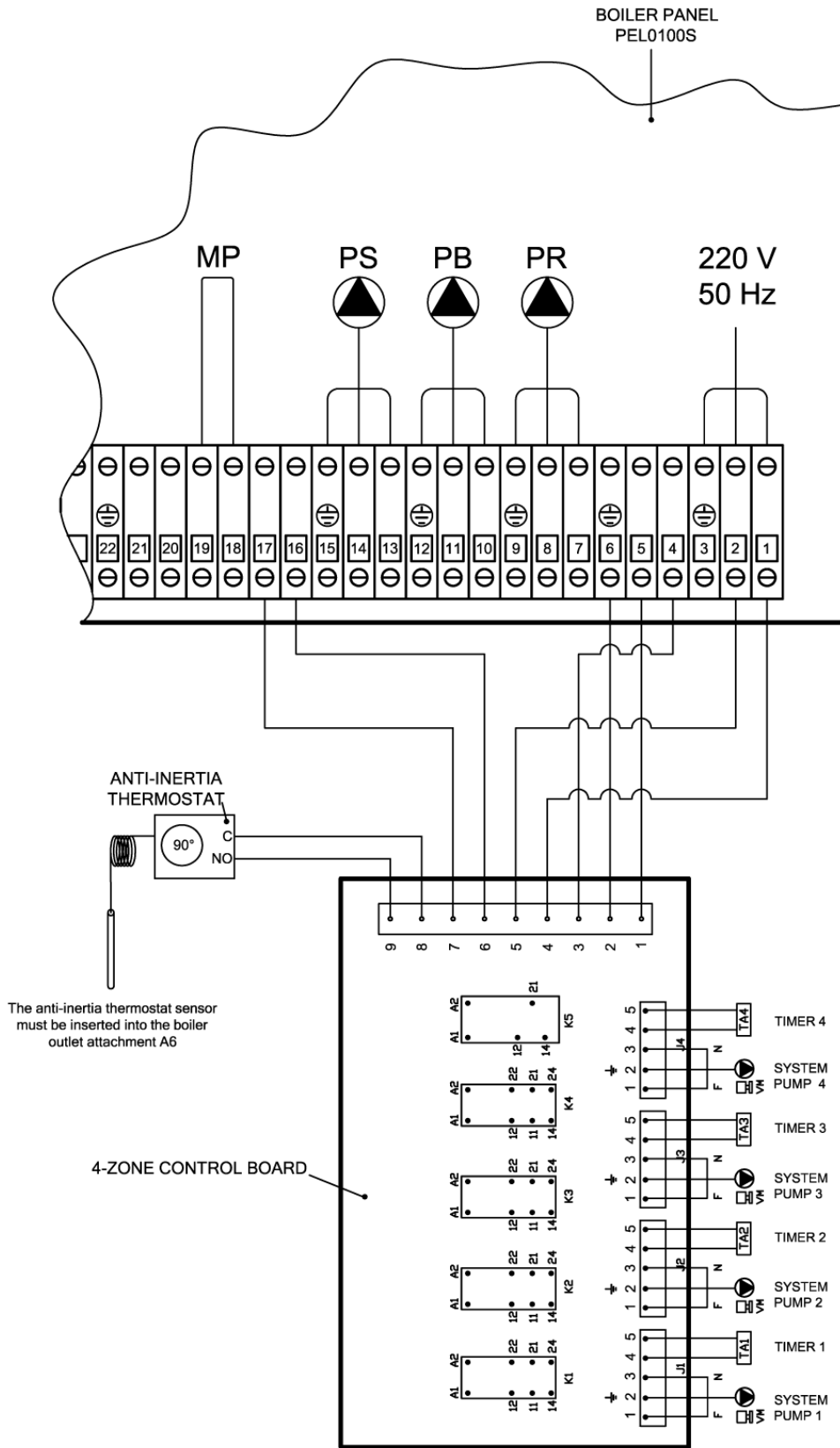

WARNING THE MAXIMUM CURRENT DRAW ALLOWED MUST NOT EXCEED 4 AMPERES.

## 10. MAINTENANCE AND CLEANING

- ❑ Before performing any maintenance always disconnect power to the boiler and wait for the appliance to reach room temperature.
- ❑ Never drain the water from the system unless absolutely unavoidable.
- ❑ Periodically check operation of the flue exhaust device and/or pipe.
- ❑ Do not use flammable substances (petrol, alcohol, solvents, etc.) to clean the boiler.

**Do not leave containers of flammable materials in the room where the boiler is installed!**

**Careful maintenance ensures cost savings and safety.**

### 10.1. Weekly cleaning

- ❑ Remove any combustion residues from all parts of the top furnace (top door).
- ❑ Using the special triangular brush supplied, clean the triangular passages in the bottom heat exchange area (bottom door).
- ❑ Remove the ash from the rear smokebox through the side doors.

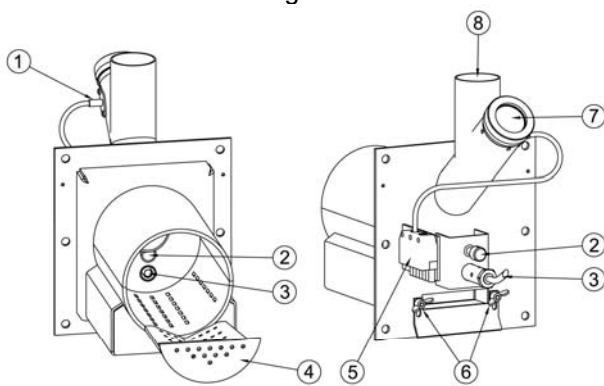

- ❑ Open the top door, remove the stainless steel grid plate (4) and use a steel brush to remove combustion residues.

**WARNING:** the presence of combustion residues on the grid plate (4) after 8-20 hours of operation indicates poor quality pellets have been used, containing a large amount of soil or bark (resins, etc.) or other non-combustible material.

These types of residue cause considerable ignition and combustion problems if not frequently removed from the grid plate (4), therefore it's strongly recommended to use good quality and certified pellets.

- ❑ Vacuum up any ash residues from the draught tube.
- ❑ Clean the photocell glass (1).
- ❑ Clean the inspection window (7).

### 10.2. Monthly maintenance

- ❑ Clean any deposits from the fan blades. Normally compressed air or a light brush ensure perfect cleaning. For more stubborn deposits, always proceed delicately to avoid unbalancing the fan and making it noisier and less efficient.
- ❑ Lubricate the motor's head bearing.
- ❑ Periodically check the condition of chimney and the draught.
- ❑ Clean the flue gas probe.
- ❑ A Make sure the primary air duct is not blocked by combustion residues or ash. Unscrew the screws that adjust air flow (6), open the duct and vacuum up the ash.

### 10.3. Annual maintenance (performed by the service centre)

- ❑ At the end of each season perform general cleaning on the boiler, making sure to remove all ash. If the boiler is not used during summer, keep the doors closed.
- ❑ Check the seal of the gaskets on the doors, smokebox and fan
- ❑ Make sure the chimney is clean

**IMPORTANT:** annual maintenance operations must be performed by qualified personnel or an authorised service centre. If replacing any faulty material always use original ARCA spare parts.

## 11. TROUBLESHOOTING

### 11.1. Electronic control panel troubleshooting

In the event of malfunctions the electronic panel shuts down the boiler and shows the type of error on the display.

The top display shows ALT, alternating with the time and the error code.

The following codes may be shown.

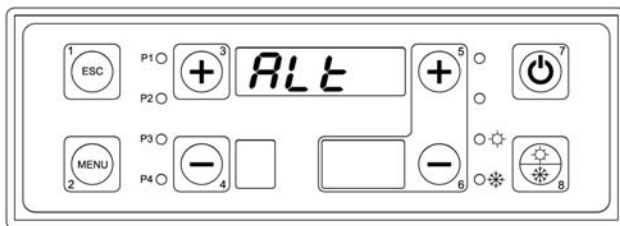

#### Error ER01.

Excess boiler temperature with activation of the safety thermostat.

To reset the error, wait for the boiler temperature to fall below 90°, press the safety thermostat button and hold button 7 for 5 seconds.

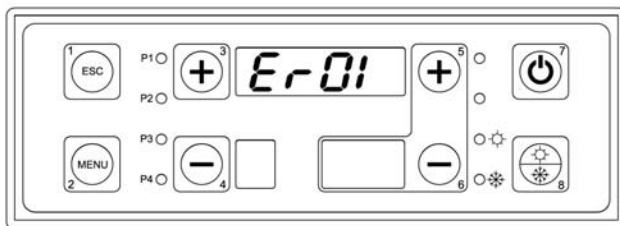

#### Error ER09

The backup battery on the main board is discharged. To replace it call a service centre.

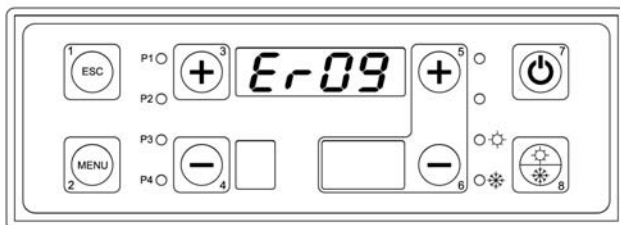

#### Error ER12

Boiler ignition has failed, as the flue gas temperature has not reached the minimum value (set by parameter) within 30 minutes.

To reset the error hold button 7 for 5 seconds.

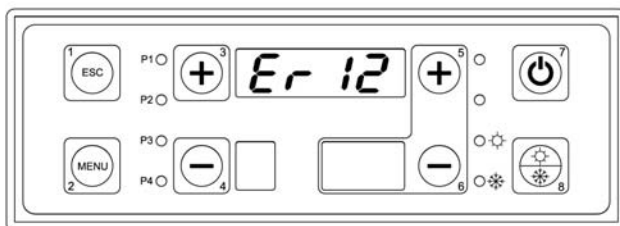

#### Error ER13.

The boiler has stopped accidentally due to the flue gas temperature falling below a minimum value set by parameter.

To reset the error hold button 7 for 5 seconds.

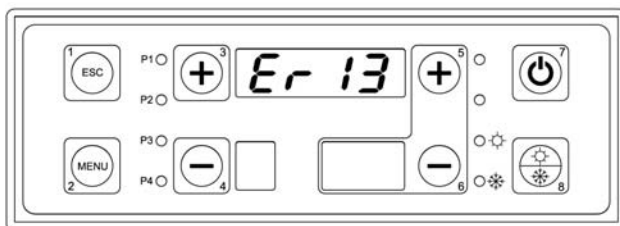

For any problem it's always recommended to contact an authorised service centre.

## 11.2. Boiler troubleshooting

Problem	Probable causes	Solutions
The boiler won't start or tends to shut down.	a) No fuel feed.	a) Check the granular fuel container: - this may be empty. - the screw motor may be blocked for mechanical or electrical reasons (call a service centre).
	b) The electric heater doesn't heat up.	b) Replace the electric heater.
	c) The burner grid plate is blocked by combustion residues.	c) Open the top door on the boiler and inspect the inside of the draught tube. If necessary clean the ignition air passage and the entire surface of the grid plate.



**ARCA s.r.l. Unipersonale**

**Registered office and biomass and steel boiler production**

Via I° Maggio, 16 (zona ind. MN Nord) 46030 San Giorgio (Mantova)

VAT no. IT 01588670206

Phone: 0376/273511 - Fax: 0376/373386 - E-mail: [arca@arcacaldaie.com](mailto:arca@arcacaldaie.com) -

Tlx 301081 EXPMN I

**Sales** - Phone: 0376/273511 - **Customer order management** - Phone: 0376/273511

**Technical department (biomass boilers)** Phone: 0376/371454

**Produzione caldaie a gas**

Via Papa Giovanni XXIII, 105 - 20070 San Rocco al Porto (Lodi)

Phone: 0377/569677 - Fax: 0377/569456